



CONTRACT TEXT    EXPAND CONTENTS  
DETACH    NO HIGH-LIGHTING

 Handbook for building homes of earth

 Table of contents

 Foreword

 **Chapter 1: Introduction - Types of earth houses**

 Chapter 2: Soils - And what can be done with them

 Chapter 3: Stabilization of soils

 Chapter 4: Where to build

 Chapter 5: Foundations

 Chapter 6: Lightweight roofs

 Chapter 7: Preparing the soil

 Chapter 8: Making adobe blocks

 Chapter 9: Making pressed earth blocks

 Chapter 10: Making walls with earth blocks

 Chapter 11: Making rammed earth walls

 Chapter 12: Roofs for earth houses

 Chapter 13: Floors

 Chapter 14: Surface coatings

 Suggested references

 Appendix

## **Handbook for building homes of earth**

APPROPRIATE TECHNOLOGIES FOR DEVELOPMENT

**Peace Corps**

INFORMATION COLLECTION & EXCHANGE

REPRINT R-34

September 1981

INFORMATION COLLECTION & EXCHANGE

Peace Corps' Information Collection & Exchange (ICE) was established so that the strategies and technologies developed by Peace Corps Volunteers, their co-workers, and their counterparts could be made available to the wide range of development organization and individual workers who might find them useful. Training guides, curricula, lesson plans, project reports, manuals and other Peace Corps-generated materials developed in the field are collected and reviewed. Some are reprinted "as is"; others provide a source of field based information for the production of manuals or for research in particular program areas. Materials that you submit to the Information Collection & Exchange thus become part of the Peace Corps' larger contribution to development.

Information about ICE publications and services is available through:

The Peace Corps Internet Web Site address:

<http://www.peacecorps.gov>

Please note the new Peace Corps Mailing Address from July 1998 on is:

ICE/ Peace Corps

1111 20th Street N.W.

Washington, DC 20526

USA

Add your to the ICE Resource Center. Send materials that you have prepared so that we can share them with others working in the development field. Your technical insights serve as the basis for the generation of ICE manuals, reprints and resource packets, and also ensure that ICE is providing the most updated, innovative problem-solving techniques and information available to you and your fellow development workers.

*This report was prepared for the Agency for International Development*

DEPARTMENT OF HOUSING AND URBAN DEVELOPMENT

OFFICE OF INTERNATIONAL AFFAIRS

WASHINGTON, D. C. 20410

## **Table of contents**

Foreword

Chapter 1: Introduction - Types of earth houses

Chapter 2: Soils - And what can be done with them

Chapter 3: Stabilization of soils

Chapter 4: Where to build

Chapter 5: Foundations

Chapter 6: Lightweight roofs

Chapter 7: Preparing the soil

Chapter 8: Making adobe blocks

Chapter 9: Making pressed earth blocks

Chapter 10: Making walls with earth blocks

Chapter 11: Making rammed earth walls

Chapter 12: Roofs for earth houses

Chapter 13: Floors

Chapter 14: Surface coatings

Suggested references

Appendix

Appendix A - Atterberg Limits of Soils

Appendix B - Useful Formulas

## **Foreword**

This report was prepared for the Agency for International Development by Lyle A. Wolfskill, Wayne A. Dunlop and Bob M. Callaway of the Texas Transportation Institute, Texas A & M University, College Station, Texas. Technical supervision was provided by this office.

This reprint is being made to provide copies to meet many demands. This handbook has proved to be one of the most helpful and most popular publications in the field of aided self-help housing.

Deputy for Technology and Information

Office of International Affairs

Department of Housing & Urban Development

## **Chapter 1: Introduction - Types of earth houses**

Probably one of the first homes man lived in after he came out of a cave, was made of earth. To be sure, the earliest known kinds of earth construction were very crude by our standards today. Primitive man did little more than stick mud on poles woven closely together. But even with this, he found shelter that was better than anything else he had except his cave. He also had the advantage of being able to move around. He could live wherever he wanted to.

Gradually, he learned that some kinds of mud made better houses than others. And some of the best ones lasted his whole lifetime.

Today, there are plenty of earth dwellings in many parts of the world that are centuries old. Man discovered that the earth homes that have lasted best were in areas where not much rain falls. A wet climate is the worst enemy of an earth house.

Today, with the advances made in the science of soil mechanics, what soils will do under many different conditions can be predicted and controlled. It is possible, even with little skill, today to build beautiful, inexpensive and durable homes using the oldest construction material known, the earth around us.

Strangely enough, it is the scientific road builders who have learned most about the way many kinds of soil will behave under a wide variety of conditions. These scientists know, for example, how to take soils that for centuries were considered useless for anything and, by combining them with materials called **stabilizers**, make them into mixtures that are excellent for earth construction.

As in most important discoveries, this new knowledge, much of it learned since World War II, was found by work done in laboratories by highly trained technical men. It now remains to make these new techniques available to the people who need them most and can use them to their advantage: the many people in the world who need good, lasting homes and who cannot afford to spend a lot of money to buy them, or who do not have

access to modern manufactured materials. Earth is everywhere.

One of the great aims of the Agency for International Development is to help fulfill this need. Under its Self-Help Program, which the AID feels gives the most help while allowing those aided to keep their dignity and pride, comes this manual as one of AID's many technical services.

This small book tries to take the newest techniques developed in modern soil mechanics and put them into simple terms so that almost anyone, anywhere, can have the benefit of the great amount of work that has been done by the scientists.

The AID authorized and paid for a research project by the Texas A&M Research Foundation, at College Station, Texas, to:

1. gather and study all available information on building homes with earth;
2. do new research in areas where not enough was known about what can be done with earth, and
3. bring this information together and present it in a form most useful for most people.

Information came from many countries and from all kinds of sources. These included books, articles, technical reports and even newspapers. More than 300 such sources were studied. In addition, soil engineers at Texas A&M University worked in their own laboratories and made tests of the materials they had and added the knowledge they developed themselves.

This manual tries to present its information in the simplest way possible. Because many things vary greatly even in one country, it is impossible to say all things to one person and have all that information apply to the place he lives.

The many kinds of climate that exist all over the world, plus the much greater number of kinds of soils that are found, make the problem of explaining just how to build a house difficult. For example, in the State of Texas, alone, what would be best to do in the eastern part would not be at all the same in the western part of the state. What would be fine in parts of the Rio Grande Valley and the Texas Gulf Coast in the south part would not be best in the Panhandle in the north.

So, this manual describes broadly the kinds of soil that are found in various parts of the world and tells what can be expected of them. It then tells what is best to do with each of them, alone or in combination with others, to make them good enough to use or make them better with the use of stabilizers. And then it explains which of the three general kinds of earth construction is best for use with the kinds of soil available. It also describes simple tests anyone can perform that tell the builder how well he is succeeding in what he is trying to do.

After chapters on picking out places to build, how to make a good foundation for any kind of house and how to build a roof, the manual has separate chapters on *adobe*, *rammed earth* and *pressed block* construction.

Because conditions and available materials change so much in different places, the builder often will want to use his own good judgment. It is therefore important, in order to get the best value out of this manual, that he read at least the early chapters carefully before deciding how best to solve his own problem.

As in any craft, the good workman has "the feel" of his job before he tries to go too far with it.

This manual, it is hoped, will give him that "feel."

## **Types of Earth Houses**

There are three main types of earth houses that the builder can select:

1. Adobe.
2. Rammed earth.
3. Pressed (or machine-made) blocks.

Two other methods that can be used are "cob" and "wattle and daub," but usually these do not make the best houses.

*ADOBED BLOCKS* - Walls made from adobe blocks are probably the most popular and one of the oldest forms of earth housing. Adobe blocks are made by placing a wet mud in boxes called "forms." The forms are removed a short time after the blocks are made and the adobe blocks are allowed to dry (or cure) for about a month before they are used to build a wall. The blocks are held together in the wall with a "mortar" which can be the same mud used for making the blocks.

The main advantage adobe has over the other methods is that it is the simplest method, and a satisfactory dwelling can be built with the least amount of construction skill. Do it right, and you can have strong walls that are relatively free from cracks. You can also make all of the blocks in your spare time and store them until you are ready to use them.

Adobe has several disadvantages. Adobe blocks are likely to be "rough looking" and chip easily. Adobe is usually not suited to climates that have more than 25-30 inches of rainfall a year.

Walls made from adobe blocks are usually as attractive or more so than rammed earth but like rammed earth, adobe often requires surfacing for a good appearance. Adobe walls probably require less work than do rammed earth walls. The attractive house shown in Figure I is an adobe house covered with stucco.

*RAMMED EARTH* - In this method, continuous walls are built by ramming moist soil into position between heavy wooden forms. When a short section of wall is completed the forms are moved upwards or sideways and the process is repeated until the walls are completed. The ramming may be done with either hand or pneumatic tampers, but either way the soil has to be rammed until it becomes dense and extremely firm. Pneumatic tampers require more skill for successful use than do hand tampers.

A well made rammed earth wall is one of the most durable earth walls that can be made. Some have lasted for centuries. Unskilled labor can do the ramming.

Rammed earth has the following disadvantages:

1. It is not easy to do well.
2. The heavy wooden forms take time, money and some skill to build.

Rammed earth construction requires the most careful selection of the soil type, or the walls will shrink and crack after they dry.

The amount of water used in the soil during the ramming must be carefully controlled to get proper ramming of the soil.

If carefully done, the finished wall may look well without any coating. But, it is common practice to stucco or paint the finished wall to produce a pleasing finish. Bonding of stucco or paint to the wall may present a problem if special surface preparation is not carried out.

*MACHINE-MADE OR PRESSED EARTH BLOCKS* - Recently, several simple and inexpensive machines have been made for pressing soil into bricks or blocks. These earth blocks have many advantages. They have approximately the strength and durability of rammed earth. Some blocks which have had stabilizers (or chemicals) added to them are nearly as satisfactory as burnt brick, lumber, or certain other building materials. At the same time, walls can be built as easily as adobe block walls. The pressed blocks dry and shrink in the sun before they are laid so that walls essentially crack free, can be built even with soils that shrink a little.

Walls made of pressed blocks have a very pleasing appearance (Figure 3) and it is not necessary to use surface coatings as long as the right soils are used. It nevertheless must be remembered that much hard work is required for handling and mixing the soil and transporting the finished blocks.

The next two methods are not recommended for a house you want to last a long time.

*WATTLE AND DAUB* - In this method, a vertical frame work of posts and poles is first constructed. Then reeds, branches, etc., are woven among the poles to form a base for a mud "plaster" which is applied to both sides of the framework. Another way is to make a double wall of poles and reeds and fill the space between with mud also. Figure 4 shows a wattle and daub house.

Shrinkage cracks often occur in walls of this type, and constant maintenance is likely to be necessary. For sick people, and some elderly people, this method of construction is not practical because a wattle and daub house might need repairs when they can least afford to do it. In many cases this is a disadvantage of the other methods already mentioned.

The method is not very practical in areas where durable species of wood are not available.

*COB* - In the cob method of construction, stiff mud is molded into balls somewhat larger than a person's head. These balls are then piled up in thick layers to form the wall directly without the use of any kind of forms. The mud must be stiff enough so that it will not have a tendency to slump. If some slumping or spreading does occur, the mud is put back in place with a trowel or else the excess mud is sliced off and placed on top. The wall must be constructed slowly so that each layer has a chance to harden before more mud is stacked on top of it. Workers usually stand or sit astride the walls so that scaffolding is not needed.

The only advantages that cob houses have are that they are easy to build and need very little construction equipment. However, shrinkage cracks can usually be expected and they may be serious.

## **Chapter 2: Soils - And what can be done with them**

Not all soils can be used successfully for earth houses. A few of them will be good in nearly any type of climate. Some of them will be good only in dry climates. Many soils can be made more suitable with "stabilizers," substances that hold them together or make them water resistant. The various kinds of soils, how to tell them

apart, and how to find out what they will do, will be discussed in this chapter.

### **Kinds of Soils**

Broadly speaking, there are five kinds of soils: gravels, sands, silts, clays, and organic soils.

*Gravel* consists of coarse pieces of rock varying in size from ¼" across to 3". (Anything larger than 3 inches is called a boulder.) Gravel can be any shape - round, flat or angular - and it can be any type of rock - granite, limestone, marble, etc. If it falls apart or even gets soft after being under water for 24 hours, it is not gravel.

Gravel is found in the beds of fast-flowing streams, in areas once covered by glaciers and around mountains.

*Sand* consists of fine grains of various rocks, mostly quartz. It varies in size from ¼ inch to about the smallest grain you can see with the naked eye. Separate grains too small to see are either silt or clay.

Sand is found in the beds of most streams, except slowly flowing ones, on beaches, deserts, and in areas once covered by glaciers.

*Silt* is rock ground up so fine you cannot see individual grains with the naked eye. Silt will tend to hold together when wet and compressed. Too much water may make it spongy, but it does not get very sticky.

Silt may be found nearly any place: in the deposits of slowly flowing streams, in the "milky" colored streams coming from glaciers or mountains or where crust blown by winds has settled.

*Clay* is a natural, earthy material that is sticky when wet but hard when dry. Separate grains are too fine to be seen with the unaided eye. There are many different kinds of clay; some of them will shrink and swell greatly with drying and wetting, while others will not.

Clays can be found in the valleys where slow-moving streams and rivers flow, in coastal plains, in the fan-shaped deposits at the bottoms of mountains.

*Organic soils* have a spongy, or stringy appearance. The organic matter may be fibrous, rotted or partially rotted vegetation, such as peat. Organic soils are very spongy when moist and have an odor of wet, decaying wood. In nature, they will nearly always contain a lot of water. They are dark-colored, ranging from light brown to black.

Organic soils are usually found where water has been standing for long periods, for example, in swamp areas. The dark-colored topsoil found in many areas owes its color to organic matter.

The five types of soils are seldom found separately. Instead, you will find mixtures of them, such as a mixture of sand and silt, or silt and clay, and so forth. By combining the names of different soil types you can describe most of the properties of a soil mixture. For example, a soil with mostly sand and a little silt would be called a "silty sand." If it is mostly silt with a small amount of sand, it would be a "sandy silt." Some common examples are: sandy clay, clayey gravel, silty clay, sandy gravel, etc.

### **What Type of Soil Is Best for Earth Houses**



The type of earth house you build, or whether you build an earth house at all, will be affected by the type of soil available and by the climate.

*Gravels* by themselves are not very good for earth houses because the particles will not pack down and hold together. Gravelly soils can be used if the rocks are not too large and if there is something to hold the rocks together such as a little clay. Clayey gravels often work out well.

*Sands* are about the same as gravels. Since they will not hold together by themselves, something else such as clay must be added. *In fact, some sandy clays and clayey sands make the best earth houses.* In the absence of good clay to mix with the sand, portland cement makes an excellent stabilizer.

*Silts* by themselves are not good for walls of earth houses. Although they will hold together, they are not very strong soils. They are difficult to compact and should not be used for rammed earth or pressed block walls. Silts also lose strength and become soft when they get wet. In wet, freezing weather they swell and lose their strength.

Silty soils can be stabilized to make a fairly good building material. Portland cement is good for sandy silts and lime works on clayey silts. Asphalt emulsion or any chemicals that waterproof such soils will do just as well.

*Clays* will pack down well if they have the right amount of water in them. In dry weather, though, they will shrink and crack and in wet weather they will absorb water causing swelling and loss of length. They would work well in extremely dry climates because they are very strong when kept dry; but, usually, clays are not found in very dry climates.

A few kinds of clays like the red iron- and aluminum-bearing clays found in the tropics (sometimes called laterites) are very stable clays. It is common practice in these areas to cut blocks of clay right out of the ground and stack them up to make earth walls. Experience of one's neighbors with this method will tell whether it is suitable in your area.

Many other clays can be made suitable with stabilizers. One of the best stabilizers for clay is lime. There are some clays that should never be used in earth houses. They just will not last.

*Organic soils* cannot be used to make a good earth wall. For one thing, they are too spongy. Soil that contains decomposing plant life continues to decompose and thus will never "set" right or hold together over a long period of time. A good rule to follow is this: if the soil is good for growing things, it will not be good for building.

Remember that the best natural soil you can use for making earth walls is a *sandy clay* or a *clayey sand*. If you happen to have such a soil, you have as good a natural building material as can be found. Without the addition of anything more than water, some kinds of sandy clays or clayey sands can be made into walls that will last a lifetime - or even longer.

If you do not have this kind of soil, you might be able to make it. If you happen to have mostly sand, maybe you can find some clay to mix with it, or if you have clay, you might find sand to mix with it.

**WHERE TO LOOK** - Often you will find a situation like this: beneath the organic topsoil, you will find a layer of sand. Below this is often found a layer of clay. By mixing the sand and clay together you might make a good

sandy clay. Also, remember that on the top of rolling hills (not mountains) or ridges you are more likely to find clays, and sands will be most common at the bottom. Probably just what you need, a mixture of both, can be discovered somewhere between.

If you are fortunate and have (or can make) a good sandy clay mix, a wise choice may be to build your house of pressed blocks which will last as long as any of the other wall types and may be easier to do. However, with a good supply of sandy clay available, both rammed earth and adobe can also be built very satisfactorily.

If the only material you can find is very clayey, probably you should build an adobe house. The clay causes the soil to shrink when it dries but since you let adobe blocks dry in the sun before you lay them in the walls, the shrinkage will not bother you too much. The next best thing to use is pressed blocks, since they also are dried before they are used. Rammed earth dries after it has been compacted in the wall and the shrinkage caused by too much clay will make the walls crack.

If your material has *too much* clay in it and not enough sand is available the only thing to do is add **stabilizers**.

If your soil is very sandy, with only a little clay in it you will not be able to build any type of earth house without adding some sort of stabilizer to it. You can probably get by with the least amount of stabilizer by making pressed blocks. Next would be rammed earth.

Probably the most difficult type of house to select a soil for is rammed earth. If the soil has a little too much clay in it this will cause shrinking and cracking of the rammed earth walls when they dry. If it has a little too much sand in it the walls might not hold up even during construction because the shocks from ramming might cause it to crumble. If you do find a soil that will be good for rammed earth it will also be good for pressed blocks or adobe. Then you can choose the type of construction you want based on which method seems to be easiest for you and gives the best looking house.

No matter what kind of soil you have it is well to bear in mind that the drier the climate year around the more satisfactory the building will be and the easier it will be to build well.

In areas where weather is subject to big changes in the course of a year such as hot weather followed by freezes which occur in much of the Temperate Zones, or areas that have definite wet anti dry seasons such as are common in the Tropic Zone, only the very best soils can be used without **stabilizers**.

All this does not mean, however that good earth houses cannot be built in wet climates or where great changes in temperature occur; it just means that under these conditions more care must be used in choosing the "raw materials" and greater attention must be given to the use of **stabilizers** and surface coatings.

*FINDING OUT ABOUT YOUR SOIL* - This is one of the most important jobs you have to do. If you make a mistake now it will cause you trouble later. [for example if you decide you have a good supply of sandy clay and it later turns out to be mostly sand, you will have to spend extra money for **stabilizers** that you had not planned on.

You will probably want your soil to come from a place as close as possible to your house.

*THE FIRST THING TO DO IS TO GET SOME SAMPLES OF THE SOILS IN YOUR AREA* - Here is the equipment that will help you do this. (See Figure S.)

1. A dirt auger to drill holes in the ground is ideal. Post hole diggers are also good, especially if you do not plan to go very deep.

2. Pipe extensions for the dirt auger. These are necessary only if you want to look at the soil at a depth greater than 4 or 5 feet.
3. Two pipe wrenches. Use these for adding the extensions to the dirt auger.
4. Shovels. If you don't have a dirt auger you can use an ordinary shovel.
5. Pick-axes or mattocks.
6. A supply of small bags (cloth, if possible) that will hold 10-30 pounds of soil.
7. A ball of twine.
8. A 6-ft. ruler.
9. Paper and pencils.
10. One or more large pieces of canvas about (6'x6') for soil samples.

The depth to which you are going to examine your soil will depend a lot on how you are going to dig the soil for your house later. If you are going to dig by hand, you probably will not want to dig more than 3 to 5 feet deep. If your soil will be dug by machine, you will want to examine the soil as deep as the machine will dig, perhaps 8, 10 or more feet deep.

First, dig out and toss aside the organic topsoil. In desert areas, there will be little or no topsoil as such. In wet, tropical areas, the top soil may be several feet thick. Once you are through the topsoil, start collecting the soil. The soil may change several different times, even at shallow depths. For this reason, you should separate each type of soil by putting it in a different pile.

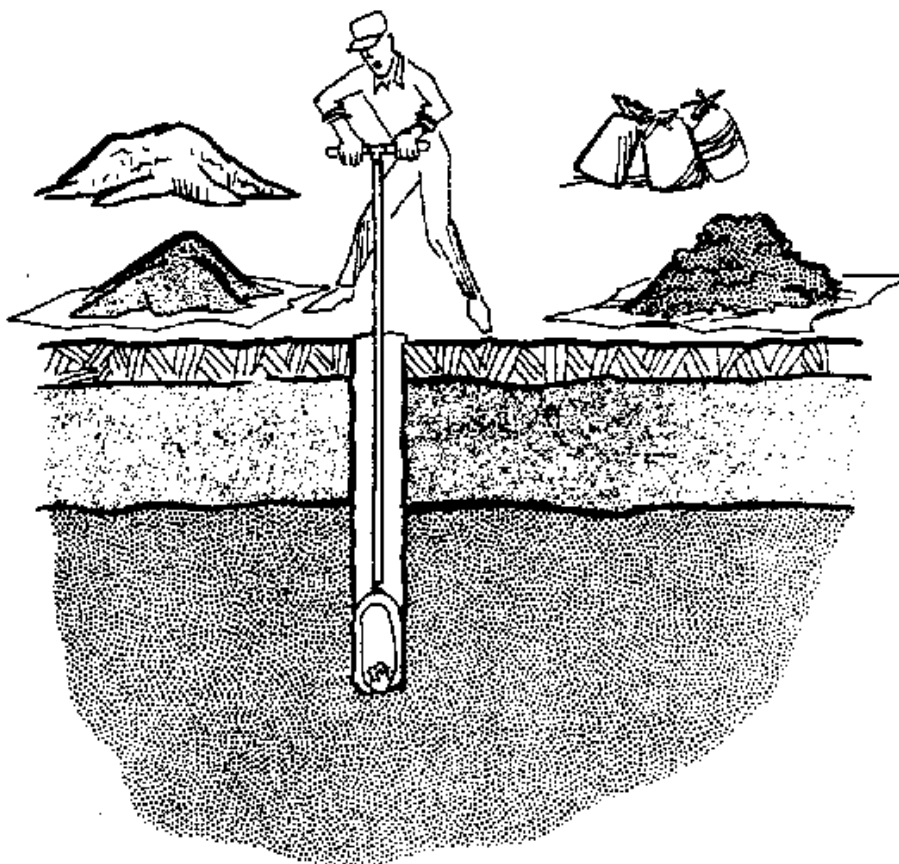

Figure 6.

Usually, but not always, a change in color of the soil will mean a change in soil type. The best way to tell whether you are changing soil types is to use the simple tests described in the next section. These tests require no equipment and can be done as you dig the soil.

Here is a typical situation. Below the topsoil you might run into a layer of sand. Save *all* of this sand and put it in a single pile. Then you come to a layer of clay. Put all of the clay into another pile, and so on. When you are finished, you may have several piles of different soils. Figure 6 shows how this is done.

As you dig, write down the thickness of each layer, the color and type of soil, and an accurate description of the location of the hole.

Soils can vary widely even within a small area. For this reason, do not be satisfied with what you find in a single hole. Instead, dig several holes in an area that is big enough to supply all of the soil you want. If all of the holes produce the same kinds of soil, combine the same types into separate piles, such as all the sand samples together, and all the clay samples together. After making some quick tests, you may decide that a mixture of what you have should work out well. Since you have saved all of the soil from the holes, you might find you have the right mixture simply by mixing the sand and clay into one pile. But at the beginning, separate all the different kinds first until you are sure of what you have.

When you are satisfied that you have examined an area completely, put each soil type in separate bags. Label each bag with the hole (or holes) and the depth that it came from. These bags of soil will be used for the tests that will decide the type of soil you have and the type of house you should build.

## How to Identify Soils

Here are some simple tests that will tell you what kind of soil you have. Do *all* of them on all your samples. Be sure that the samples that you test accurately represent the soils you will use in building.

If you are testing sands or gravels, first dry the soil by heating or spreading a sample in the sun. Make it into a cone-shaped pile, and carefully divide it into four equal samples. Combine two opposite portions into one sample and set aside the other two. You should end up with about a shovelful of soil. If there is too much soil after one such separation, repeat the process of dividing and discarding until a suitable size soil sample remains.

**VISUAL TESTS** - The appearance of a soil can tell you some important things about it. First spread the dried soil out in a thin layer on a flat surface. Then roughly separate the sand and gravel sizes by hand.

Do this by putting all of the particles from the largest down to the smallest that you can see with the unaided eye in one pile. This will be the semis and gravels. What is left (normally this will be very fine powder-like materials) will be the silts and clays. If the silt and clay pile is large; than the sand-gravel pile, call the soil silt-clay for now and *remember* this. Other tests, described later, will tell you which it is.

If the sand and gravel piles together are bigger, you have a sand or a gravel. Decide which it is by putting all of the particles larger than ¼" (gravels) in one pile and all of the smaller particles (sands) in another pile. The soil is gravelly if the gravel pile is biggest and sandy if the sand pile is biggest. *Remember which it is.*

Here is what you do if you have a sandy or gravelly soil:

Take a small handful of the entire sample (not just the sand and gravel), get it moist but not soupy, squeeze it into a ball, and let it dry in sun. If it falls apart as it dries, call it "clean." Clean sands and gravels are not suitable for earth houses unless they are mixed with other materials.

Here is what you do if you have a silt-clay soil or a sand or gravel that is not clean:

Take the *entire* sample and collect all of the soil that is smaller than medium sand (1/64") by sifting through a very fine screen or a piece of coarse cloth. The tests described below should be made with this fine material.

**WET SHAKING TESTS** - Take enough of the soil to form a ball the size of a small hen's egg and moisten it with water. The ball should have just enough water in it so that it will hold together but not stick to your fingers. Flatten the ball slightly in your palm and shake the ball vigorously. This is done by jarring the hand against some firm object or against the other hand until the shaking brings water to the surface of the sample. The soil may have a smooth, shiny or "livery" appearance when this happens. (What you are looking for is to see how fast the water comes to the surface and gives the livery appearance.) Then, squeeze the sample between your thumb and forefinger to see whether or not the water disappears.

The following are terms used in describing the speed of the above reaction (See Figure 8):

1. *Rapid* - When it takes only five to ten taps to bring water to the surface, this is called a rapid reaction. Squeezing the sample should cause the water to disappear immediately so the surface looks dull. Opening the hand quickly should accomplish the same result. Continued pressure causes the sample to crack and finally crumble. This type of reaction is typical of very fine sands and coarse silts. Even a little bit of clay will keep the reaction from being rapid.

2. *Sluggish (or Slow) Reaction* - When it takes 20 to 30 taps to bring the water to the surface, you have a sluggish

reaction. Squeezing the sample after it has been shaken will not cause it to crack and crumble. Instead, it will flatten out like a ball of putty. This shows that the soil has some clay in it.

3. *Very Slow or No Reaction* - Some soils will not show any reaction to the shaking test, no matter how long you shake them. The longer it takes to show a reaction, the more clay the soil contains. These soils will require the other tests described below before you can tell much about them.

**THREAD TEST** - To a lump of soil about the size of an olive, mix just enough water so the lump can be easily molded in your hands, but is not sticky. Next, on a flat clean surface roll out the soil into a thread. Use the palm of your hand or fingers and exert just enough pressure to make the soil thread get continually smaller. If it breaks before you roll it out to a 1/8" diameter thread, it is too dry and you need to add some more water to it. When the soil is at the right moisture content, the thread will begin to crumble into several small pieces just when you get it to a diameter of 1/8" - If the thread does not crumble and break at 1/8", lump it together again, knead it into one lump, and repeat the rolling process until the thread crumbles at 1/8" diameter. (The thread will eventually crumble because it dries as you keep rolling it out.)

As soon as the thread crumbles, re-mold the sample into a ball and see how much pressure it takes to squeeze the ball between your thumb and forefinger.

This test gives an idea of how much clay is in a soil and also what type of clay it is. If the soil crumbles easily and you cannot roll the soil into a thread at any moisture content, it means that the soil does not have any clay in it. Here are some of the other reactions you can expect:

1. *Tough Thread* - If the remolded ball can be deformed only with a lot of effort and it does not crack or crumble when you do it, your soil has a lot of clay in it. It probably will not be good for earth walls unless you use a stabilizer.

2. *Medium Strength Thread* - This kind of soil can be remolded into a ball, but when the ball is squeezed between the fingers, it will crack and easily crumble. This soil may be good but may require some stabilization for certain areas. Check Table I to be sure.

3. *Weak Thread* - When the soil has a lot of silt or sand and very little clay, you will find that the threads cannot be lumped together in a ball without completely breaking up or crumbling. This soil may be good for earth walls; check Table I to be sure.

4. *Soft, Spongy Thread* - Sometimes you will find that the threads and the ball that you make with them will be spongy and soft. You can squeeze the ball between your fingers, but it acts like a sponge and bounces back. When this happens, the soil is organic and it's not suitable for building earth houses.

**RIBBON TEST** - This test gives about the same kind of information that the thread test gives. It helps to do both tests. One checks out the other.

Take enough soil to form a roll about the size of a cigar. The roll should not be sticky, but wet enough to permit being rolled into a 1/8" diameter thread without crumbling, as in the thread test. Put the roll in the palm of your hand and, starting at one end, flatten the roll by squeezing it between the thumb and forefinger to form a ribbon between 1/8" and 1/4" thick. Handle the soil very carefully to form the maximum length of ribbon that the soil will support. See how long the ribbon will hold together without breaking. The reactions you can expect-are described below.

1. *Long Ribbons* - With some soils the ribbon will hold together for a length of 8 to 10 inches without breaking.

This means that the soil has a lot of clay in it. Soils of this type will make long-lasting earth walls only if they are stabilized.

2. *Short Ribbons* - If you can - with some difficulty - ribbon the soil into short lengths of about 2 to 4 inches, the soil has a medium to small amount of clay in it. It will be about the same as the soils that give a medium or weak thread in the thread test. This soil will make good walls in many cases but to be sure check Table 1.

3. *Will Not Ribbon* - Some soils cannot be formed into ribbons at all. This means that they contain either a very small amount of clay or none at all. Such soils with a little clay may make good rammed earth walls. If the soil is all sand it is not suitable unless stabilized heavily with portland cement; to be sure, check Table 1.

*DRY STRENGTH TEST* - This is another simple test that will help you determine how much clay you have in the soil. Prepare two or three wet pats of the soil about ½" thick and 1" to 2" wide. Use enough water to make the soil quite soft but still strong enough to hold its shape when you form it into pats. Then allow the pats to dry in the sun or in an oven until they are dry all the way through. Break the soil pat and then try to powder it between your thumb and forefinger. Here is what you are looking for:

1. *High Dry Strength* - If the sample has high dry strength it will be very difficult to break. When it does break it will snap sharply, like a crisp cookie. You will not be able to powder the soil between your thumb and forefinger. You may be able to crumble it a bit with your fingers, but don't confuse this with powdering the soil. Soils with this reaction have a lot of clay in them, and they will be satisfactory only if stabilized.

2. *Median' Dry Strength* - When a soil has a medium dry strength, it will not be too hard to break the soil pat. With a little effort you will be able to powder the soil down to its separate grain sizes between your thumb and forefinger. This soil is good but may require a stabilizer to reduce shrinkage; check Table 1.

3. *Low Dry' Strength* - A pat with very little clay will break without any trouble. It will powder easily. Pats of very sandy soils will crumble in your hand before you have a chance to powder them. Before a final decision on the use of this soil, check Table 1.

The four tests described above are the most important ones and it will pay you to use them all in finding out about your soil. There are some other simple tests that will also aid you. Use them if you need to. They are given below.

*ODOR TEST* - Organic soils have a musty odor, especially when freshly dug. You get the same odor for dry organic soils by wetting and then heating them. Don't use these soils in earth walls.

*BITE TESTS* - This is a quick and useful way of identifying sand, silt, or clay. Take a small pinch of the soil and grind it lightly between your teeth. Identify the soils as follows:

1. *Sandy Soils* - The sharp, hard particles of sand will grate between the teeth and will create an objectionable feeling. Even very fine sands will do this.

2. *Silly Soils* - Silt grains are much smaller than sand particles and although they will still grate between the teeth, they are not particularly objectionable. They feel a lot smoother than sands.

## **TABLE 1**

## **SILT-CLAY SOILS**

If the silt-clay pile was larger than the sand and gravel piles together, then use the Table below to determine what kind of soil it is.

### **Names of Soil**

### **Reaction to Wet Shaking Test**

### **Dry Strength Test**

### **Thread Test**

### **Ribbon Test**

### **Additional Tests**

### **Suitability for Earth Homes**

### **Stabilizers**

### **Comments**

Very fine sands, silty fine sands, clayey fine sands, clayey silts

May be rapid to sluggish, but never very slow

Low to none; usually none

Weak thread to no strength in thread

Short ribbons; may not ribbon at all

Washes off hands easily. Will not stain hands

Usually suitable for all types, particularly adobe if stabilized

Portland cement most suitable. Asphalt emulsions also work as do most waterproofers

May be affected by frost

Silts, very



May be anything from sluggish to none

May be low to medium

Weak to medium strength thread

Short ribbons

Should not be used if possible. Stabilize heavily if necessary to use

Portland cement, asphalt emulsions if soil is not too sticky

Will usually require surface coatings in addition to stabilizers

Gravelly clay, sandy clay, silty clay

May be very slow to none

May be medium to high

Medium strength thread

Short to lone ribbons

Will usually require stabilizers most suitable for rammed earth and pressed blocks

Lime Sand Gravel

Can be very good if amount of sand or gravel is high

Clays, fat clays

None

High to very high

Touch thread

Long ribbons

Very sticky when wet, difficult to wash off of hands

Should never be used for earth houses

Organic silts, organic silty clays

Sluggish

Low to medium

Weak thread and feels spongy

Short ribbons or may not ribbon at all. Spongy feel

A Pat of moist soil has a mushy odor when heated

Should never be used for earth houses

Organic silts, organic clays

Maybe very slow to none

Medium to high

Weak to medium. Threads feel spongy

Short ribbons, spongy feel

A pat of moist soil has a mushy odor when heated

Should never be used for earth houses

## **GRAVEL SOILS**

**If the gravel pile was larger than the sand pile, then use the**

**Table below to decide what kind of gravel it is.**

Silty gravels, sand-silt-gravel mixtures

Rapid

Low to none; usually none

No strength of thread

Will not ribbon

Fine material washes off easily. Will not stain hands

Usually suitable if it is first stabilized. If almost a "clean" gravel it may be necessary to first add more fines

Portland cement most suitable. Asphalt emulsions may also work.

May be affected by frost

Clayey gravels, gravel-sand-clay mixtures

Sluggish to very slow

Medium

Medium strength thread

Short ribbons, may be long

Finer material not easily washed off of hands

May be very suitable for all types of earth houses. If almost clean, it may be necessary to add some fines

Lime most suitable. Portland cement may work if soil mixes easily

Clean gravel

Not necessary to run these tests on clean gravels

Not suitable for earth houses. Can be mixed with fines(silt or clay) to make suitable soils for earth houses

If well graded, will be very good for aggregate in concrete for foundations

## **SAND SOILS**

**If the sand pile was larger than the gravel pile, then use the**

**Table below to decide what kind of sand it is.**

Silty- sands

Rapid

Low to none, usually none

No strength of thread

Will not ribbon

Fine material washes off easily. Will not stain hands

Usually suitable if stabilized. If almost a "clean" sand it may be necessary to add more fines

Portland cement is best. Asphalt emulsions may work clayey fines

May be affected by frost

Clayey sands

Sluggish to very slow

Medium

Medium

Short ribbons but may be long

Fine material not easily washed off of hands

Usually very suitable for all types of earth houses If almost clean, may add some clayey fines

Lime is best. Portland cement will work if soil mixes easily

Clean sands

Not necessary to run these tests on clean sands

Not suitable for earth houses unless mixed with fines

Clayey fines

If well-graded will be good for aggregate in concrete for foundations

3. *Clayey Soils* - The clay grains are not gritty at all. Instead, they feel smooth and powdery like flour between the teeth. You will find that a *dry* pat of soil with a lot of clay in it will tend to stick when lightly touched to your tongue.

*SHINE TEST* - Take a pat of either dry or moist soil and rub it with your fingernail or the flat side of a knife blade. If the soil contains silt or sand - even with the remainder being clay - the surface will remain dull. A soil that has a lot of clay in it will become quite shiny.

*TRY WASHING YOUR HANDS* - You can tell a lot about a soil in the way it washes off of your hands. Wet *clayey* soils feel soapy or slick, and they are hard to wash off. Silty soils feel powdery like flour, but they are not too difficult to wash off. Sandy soils rinse off easily.

*Color* is important in classifying soils. Olive-greenish and light brown to black colors may mean organic soils. Red and dark brown colors may come from iron in the soil. Soils with a lot of coral, limerock, gypsum, and

caliche may be white or some shade of gray.

After you have done all of the tests given above and have decided what the reactions to them are, you are ready to use Table 1. It will tell you exactly what kind of soil you have and what kind of house you can build with your soil.

Here is the way to use Table 1: Suppose you found that your soil was a gravelly soil. This means that the sand and gravel piles together were larger than the silt-clay pile, and the gravel pile was larger than the sand pile. Use the gravel chart in Table 1 - this is for the gravels. Suppose the tests you did on the part that passed the fly screen showed your soil reacted rapidly to the shaking test, had weak soil threads and very low dry strength. Then your soil would be a silty gravel. It would not be suitable for earth houses without stabilization.

### **Getting More Exact**

Of course, the tests just described are pretty crude according to the standards of a soils engineer. But once you have performed them a few times and "get the feel" of your soil they will give you the information you need.

However, in order that you might know what a soils engineer would do, following is a list of tests that he would perform (or you could do yourself if you had the equipment). If you can do these tests yourself, or have someone do them for you, tables - similar to Table 1 can be used to determine more accurately the type of soil you have and what can be done with it. The tests are described in detail in Appendix A.

1. *Gradation tests* will tell you more exactly about the size of soil particles. There are two techniques of doing this, a simple method which uses little equipment, and a more complicated method involving special equipment.
2. *Lineal shrinkage tests* are a fairly accurate and simple way of telling how much clay your soil contains and how the clay will act as far as shrinking and swelling is concerned.
3. *Atterberg limits* give you much the same information that the lineal shrinkage test does, but more accurately.

### **Tests on Blocks**

The simple field tests you have done tell you much more than you knew about your soil before. But these tests alone can't tell you everything you need to know about your soil. For this you must do some more tests. These tests will require you to make some actual blocks of the type of construction recommended for your soil in Table 1. It takes about a month to make, cure and test the samples, but it is worthwhile. Your house, well made, will last a lifetime.

It is best to use actual size blocks as test samples, but if you are testing many different soils, or one soil with several stabilizers, this may require a large quantity of soil. Then, you can make smaller test samples roughly this size: 6x3x2 inches. You will need 7 test blocks of each soil. This will take about 4 shovelfuls of soil for these blocks.

If Table I shows that your soil might work with more than one type of earth construction, then the best thing to do is to make 7 test samples of each type recommended, test the samples, and then decide on the type of construction to use.

When you have done all the tests and finally decided on your soil and type of construction you will use, it is a good idea to make a few actual size blocks (if you used 6x3x2-inch blocks in your evaluation tests) and test them just to make sure they act like the smaller blocks.

Here is what you do for the different types of earth construction.

*ADOBE* - First, see how water mixes with your soil. If it doesn't mix easily into a smooth mud, but instead sticks to everything including your mixing tools, it won't make a satisfactory adobe house. (It contains too much clay.)

If you still would like to use adobe construction anyway, you will have to add a stabilizer. There are several, as you will see from Chapter 3, but let's suppose you've decided to use lime.

For one test block mixture, add one part of lime to 50 parts of soil; for another, add one part lime in 25 parts soil, and for another, one part lime in 17 parts soil. Make enough

Of each of these mixtures to make 7 blocks. Mix the soil and stabilizers together until you get a uniform color. Mixing is very important; so, do it well.

Then - whether your soil has stabilizer in it or not - gradually add water until you have a thick mud. You can tell when it is right by running a pointed stick through it. If the bottom of the groove barely closes due to its own weight, it is right.

Place your wet soil mix in a form box. Figure 11 shows a form box for small samples that has enough space for eight blocks, 6x3x2 inches.

You can be sure the forms are properly filled by working the mud around a bit with your hands until there are no more air pockets. Scrape the excess mixture from the top of the form with a board or the edge of your shovel.

Let the form set about fifteen minutes so that it can be lifted off the blocks without the blocks losing their shape very much. *If the blocks slump or settle*, you have added too much water and you should begin again.

After a few days turn the blocks on edge and let them cure. Let *unstabilized* blocks cure in the sun for *four weeks*.

If the test blocks contain a stabilizer they should be sprinkled for at least the first week or else kept fully covered to keep them moist. Blocks should be protected from rains with anything that will keep the water off them. At all times however air should be able to get to them.

While the blocks are curing if large open cracks appear you can tell without waiting for four weeks that they contain too much clay. Full size adobe blocks should not have more than 2 or 3 narrow cracks and these should not go completely through the block. The small 6x3x2-inch blocks should not have any cracks at all. If the blocks can be crumbled easily after a week or so the soil is too sandy.

When the adobe blocks are fully cured they are ready to be tested.

*PRESSED BLOCKS AND RAMMED EARTH* - One of the differences between making adobe block and pressed block or rammed earth lies in the amount of water used in preparing the soil. Adobe, we will call wet; the others should only be "moist." It is Important to get the right amount of moisture in the soil. Proper anti complete mixing is also essential.

To check the moisture content take a handful of moist soil and make a ball with your hands about the size of a small orange. Press it together as firmly as you can. Then drop it onto a hard surface from shoulder height. If it shatters into pieces so that it is about the way it was before you molded it the moisture content is right. If it breaks into a few large pieces or flattens out it is too wet. If it is difficult to press into a ball that holds together or if you

can crumble it easily between your fingers it is too dry. This test will apply whether the soil is stabilized or not.

Once the moisture content is correct you are ready to make trial pressed blocks or rammed earth.

Of course if you have a machine for making full size blocks. use it. If you do not you will need a mold such as shown in Figure 12 and some means of applying pressure to compact the soils. You should apply about 300 pounds for every square inch of block surface so the molds will have to be able to withstand a lot of pressure. Make each of the trial blocks exactly the same way.

Remove each block from the mold and allow it to cure the same way as the adobe for four weeks. Look for cracks in the blocks during the curing period. If full size blocks contain more than one narrow crack in them, they will not be suitable.

### **Rammed Earth**

Make a form as shown in Figure 13, about one foot by one foot by eight inches deep inside. It should be made of seasoned lumber that will not shrink, and it should be coated with oil before using it. Then make a tamper for ramming the earth. A simple tamper can be made by threading a heavy, flat-faced piece of metal on to a piece of pipe.

Fill tile form (not including the collar) about  $\frac{3}{4}$  full of loose well mixed soil and ram it 50 times. Then put the same amount in the form again, and ram it 50 times. You should end up with a block - made up of 2 layers - slightly more than inches thick. Use a knife or flat piece of steel to smooth the top of the block. Be sure that you ram each of the trial blocks the same way as all the others.

Remove the form from all blocks except the last one made and cure the blocks the same as adobe. The last block should be carefully cured in the form. If the soil shrinks away from the form as it dries, it will not be suitable for rammed earth.

*TESTS ON BLOCKS* - After all test blocks have cured for at least four weeks, the test described below can begin.

*ABSORPTION TEST*- This test tells you how fast your blocks will soak up water and whether the water will cause them to swell. It should be done on every soil you intend to use in earth walls, regardless of the type of construction used. If you have several soils available and are trying to decide which one to use, this test can help you decide.

Equipment and supplies needed:

1. Two of your seven blocks of each soil mixture.
2. A shallow pan that will hold water at least 1" deep, and large enough to hold several blocks at once. Use heavy wire grating or mesh to fit in the pan for the samples to rest on. The grating should be placed in the pan so the samples will be in  $\frac{1}{8}$ " of water. Support the wire grating in several places so it will not collapse when several samples are placed on it. Make a hole in the side of the pan at the correct level so that the water will not get higher than  $\frac{1}{8}$ " on the samples. Then, by letting a small amount of water drip in the pan and run out of the hole you can be sure that the samples will always be exactly  $\frac{1}{8}$ " deep in water. Figure 14 shows how one of these pans looks.

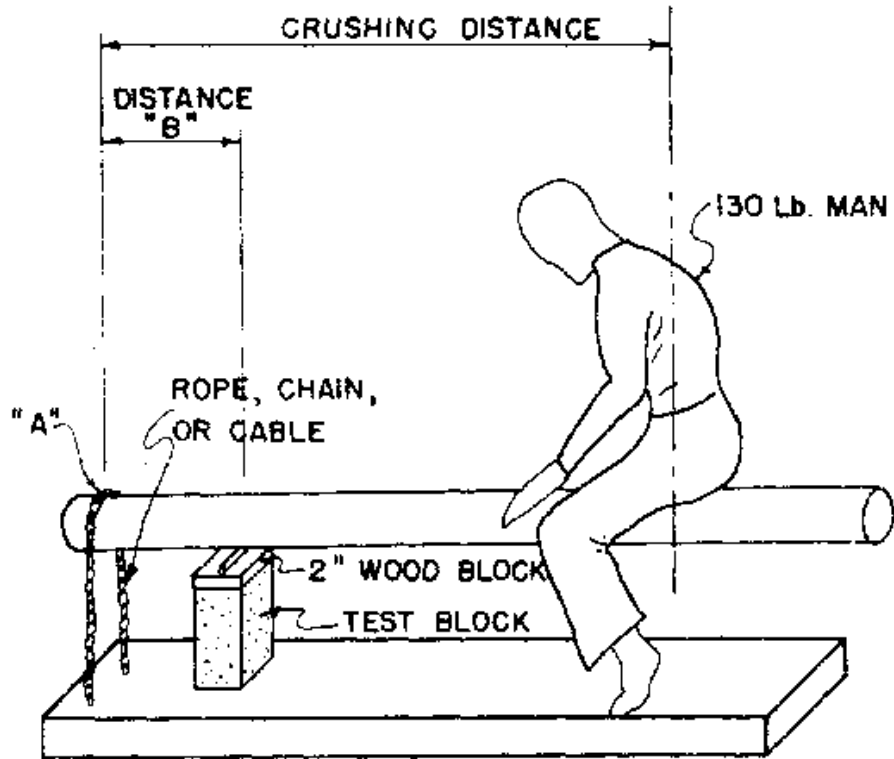

Figure 15. Simple lever test for determining strength of blocks (see Table 2).

3. Fine wire screen (like fly screen) to be placed between the blocks and the wire grating to keep weak samples from falling through the wire grating.
4. A left. ruler divided to 1/16ths inch with at least 1 inch divided into 1/32nds inch.
5. Wax paper or plastic sacks if available. Get the right size to fit loosely over the samples. These sacks are not absolutely necessary hut they will make your test more accurate because they keep water from evaporating from the samples. They are most useful when the test is performed in hot dry weather.
6. A supply of clean water.
7. A clock or watch.
8. A form such as shown on Figure 17.

The test starts as soon as the block touches the water. Blocks are stood in exactly 1/8" of water. As they soak up the water you will see a wet line extending around them. After 5 minutes, with your ruler measure the height of the water line above the bottom of the block. Often this line will not be straight and level. Measure the best average height you can get to the nearest 1/16". Measure again at the following times: 1, 2, 4, 8, 24 hours and once each day thereafter or until the water reaches the top of the block. The heights that you measure should be written down on your form. Also, write down the time when the water rises to the top of the block and all of the block is wet.

If you have a scale, weighing the blocks each time you measure heights will give a better idea of when the block stops absorbing water. There is a space for the weights on the form.

To check whether the block swells, measure the longest side of the block to the nearest 1/32" before the test



starts. At the end of the test measure the block again at exactly the same place. There is also a place for these measurements on the form.

A good time to test your blocks for strength is at the end of the absorption test, because they are in their weakest condition then. Test them as soon as the water line reaches the top of the block and call this the "wet" strength of the block.

*STRENGTH TEST* - The strength of soils is determined by crushing (compressive strength) rather than by pulling apart (tensile strength). This test is very important for earth houses and should be done with a great deal of care.

Equipment and supplies needed:

1. Two of your dried, cured blocks plus the two absorption test blocks. The size and shape of the blocks is very important when testing a soil to determine its compressive strength. They should be roughly twice as long as they are wide. Your 6x3x2-inch blocks are ideal, but the rammed earth blocks should be trimmed to size first. Do this carefully so the blocks are not damaged.

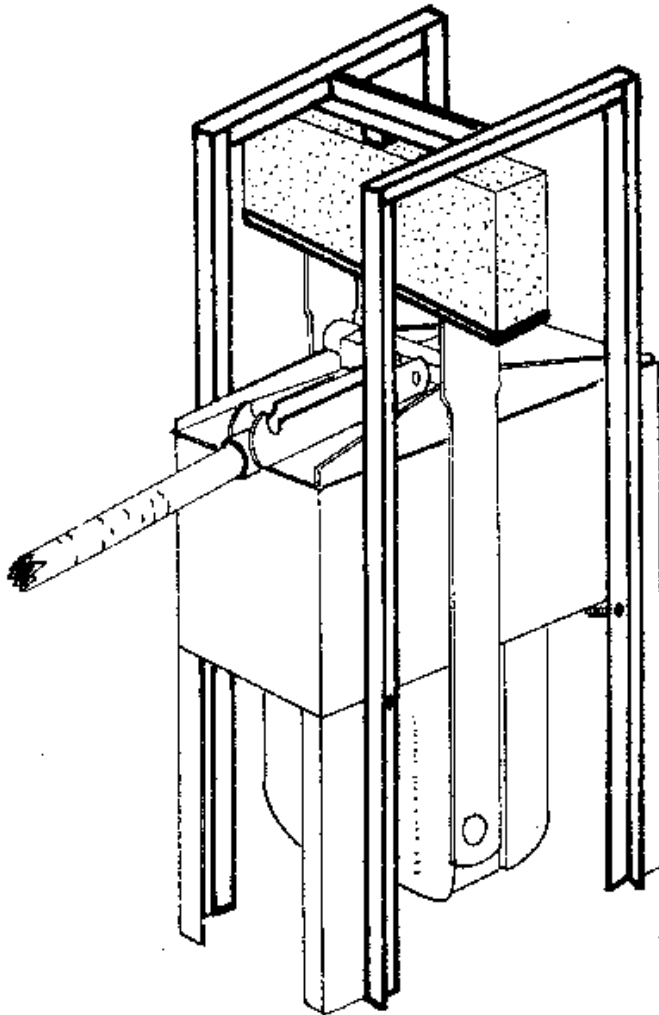

Figure 17.

2. A way to apply and measure the load to crush the blocks. In commercial laboratories they use a machine. Another way is to use a hydraulic jack with a gage on it that will accurately measure the crushing load. You can also make an attachment for the CINVA-Ram block-making machine as shown in Figure 17 that will break the blocks. Note, that in this figure the block is not in the correct position for a compression test. You can also make a simple, lever type machine such as the one shown in Figure 15.

3. A left. ruler divided to 1/16th inch.

4. A copy of the form shown on TEST FORM.

The methods discussed here will be easy ones which require little or no equipment. If you have any of the better equipment mentioned above, the test procedure will be about the same. The results will be more accurate, of course.

The blocks should be tested by loading them in the direction of their longest dimension. Make sure that the top and bottom are square so the block does not tilt during loading. The exact area of the block is important. To get it, measure the exact dimensions of the crushing face, and multiply them together. Write this down on your form.

## **TEST FORM**

### **Soil Information**

Location of Soil \_\_\_\_\_

Depth \_\_\_\_\_

Type of Test Block (Circle One) Adobe Pressed Block Rammed Earth Amount and Type of Stabilizer \_\_\_\_\_

### **Absorption Test**

### **Height of Water Line**

### **Weight of Block**

#### **Time**

No. 1

No. 2

No. 1

No. 2

0

5 mins.

1 hr.

2 hr.

4 hr.

8 hr.

24 hr.

2 days

3 days

4 days

5 days

6 days

7 days

Time for water to reach top of block\_\_\_\_\_

Length of block before start of test\_\_\_\_\_

Length of block at end of test\_\_\_\_\_

### **Strength Teat**

#### **Dry Blocks**

#### **Wet Blocks**

Block 1

Block 2

Block 1

Block 2

Area of block, square inches

Crushing distance, ft.

Crushing strength

### "Simple" Strength Test

Block 1 (circle one) - Very soft, soft, medium, stiff, very stiff, hard

Block 2 (circle one) - Very soft, soft, medium, stiff, very stiff, hard

### Spray Teat

Depth of Pits; Block 1, Block 2

Remarks \_\_\_\_\_

Using the lever arrangement shown in Figure 15, place the block the lever and apply the load. Figure 15 shows a 130-pound man sitting on the lever, but you could also hang a bucket of stones or water (or anything weighing 130 pounds) from the lever. Start with the man or weight close to the block and move slowly outward to the end of the lever until the block breaks. Then measure the distance from the end (or chain) to the weight. Call this the *Breaking Distance*. Form Table 2, you can find the crushing strength of the block. For in-between dimensions not shown in the Table, you can estimate with good accuracy.

Even if you cannot make the lever machine shown in Figure 1 S. you can still estimate the wet strength of blocks following the absorption test. (All dry blocks will be hard, and it would be difficult to even estimate the difference in strength between several blocks without some sort of equipment.) For this, use the "simple" strength below:

"Simple" *STRENGTH TEST* - The reactions that you can expect to this test are as follows:

*Very Soft* - The block can be easily pinched apart with only the thumb and forefinger or it may even slump under its own weight.

*Soft* - If the block can be easily penetrated several inches with the thumb, call it "soft."

*Medium* - If the thumb will penetrate a block about 1 inch with moderate effort, it is of medium strength.

*Stiff* - Soils which are stiff can be indented with the thumb, but only with great effort.

*Very Stiff* - The soil cannot be penetrated at all with the thumb, but it can be penetrated with the thumbnail.

*Hard* - Very difficult to dent with the thumbnail.

## **TABLE 2**

### **CRUSHING STRENGTH OF BLOCKS FROM SIMPLE LEVER TEST**

**Area of Block in Square Inches**

**Dist. "B"**

**"CRUSHING DISTANCE" (Length From End of Lever To Weight For Blocks of Strength Shown)**

**100 psi**

**125 psi**

**150 psi**

**250 psi**

**300 psi**

**4**

12"

3'-0"

3'-10"

49'- 7"

3'-10"\*

4'-10"\*

4½

12"

3'-59"

4'-4"

4'-2"

4'-4"\*

5'-2"\*

5

12"

3'-10"

4'-10"

5'-9"

4'-10"\*

5'-9"\*

5½

12"

4'-2"

5'-4"

6'-4"

5'-4"\*

6'-4"\*

6

12"

4'-7"

5'-9"

6'-11"

5'-9"\*

6'-11"\*

6½

12"

5'-0"

6'-3"

7'-6"

6'-3"\*

7'-6"\*

7

12"

5'-5"

6'-9"

8'-1"

6'-9"\*

8'-1"\*

7½

12"

5'-9"

7'-2"



8'-8"

7'-2"\*

8'-8"\*

8

12"

6'-2"

7'-8"

9'-3"

7'-8"\*

9'-3"\*

18

6"

6'-11"

8'-8"

10'-5"

8'-8"\*

10'-5"\*

19

6"

7'-4"

9'-2"

11'-0"

9'-2"\*

11'-0"\*

20

6"

7'-8"

9'-7"

11'-6"

9'-7"\*

11'-6"\*

Where \* appears, use 2 men (or 260# weight) on lever. Measure distance from point "A" of lever to center of the weight.

The only blocks which will be normally suitable for earth houses are those which are called "hard." "Very stiff" ones may be suitable for dry areas.

Remember to do the strength test on both the dried, cured blocks (call this the dry strength) and on wet blocks after the absorption test (call this the wet strength). Always use at least two of your blocks to determine their strength. Use the average strength of the two blocks.

*SPRAY TEST* - This test tells you how your block will hold up in a hard, driving rain. Most accurate results require laboratory equipment, but there is also another way that is satisfactory.

Equipment and supplies needed:

1. Two of your seven blocks of each mixture.
2. A spray nozzle that can produce a hard spray all over a block. A four-inch diameter shower head is usually used.
3. Some wire mesh covered with fly screen, such as used in the absorption test, to place your blocks on.
4. A water supply that will deliver a fairly constant pressure for two or more hours. The water pressure usually used is 20 pounds per square inch.
5. An accurate gage for measuring water pressure. Mount the gage in the pipe supplying water to the spray nozzles at a point near the nozzles.
6. A copy of the form shown on TEST FORM.

Place the wire mesh on bricks or wood blocks so it is suspended a few inches off the ground. Then put the test blocks on the mesh with their largest face square to the spray nozzles and exactly 7 inches from the nozzles. Start the water spray, keeping the water pressure as close as possible to 20 pounds per square inch.

After two hours of spraying remove the blocks and examine them closely. Measure the depth of pitting or surface erosion. Also write down the time required for any blocks to completely fall apart or get washed away by the spray.

Be sure and write down the results of the spray test on your form with the results of the other tests so you will have a permanent record of all of the tests.

Now that you have done these tests, you must look at the results and decide whether your blocks are suitable for making earth houses. Remember that soils vary a lot. It will be hard - even with these fine tests to tell exactly how your soil will act. But if you use the tests wisely, and benefit from your neighbor's experience with earth houses, you should be able to build a safe house.

Start by looking at the results of the spray test. If you live in an arid (dry) area - one where the rainfall is less than 20 inches per year - then your bricks are satisfactory if they have some pitting, say ¼" to ½" deep

If you live in an area where the annual rainfall is between 20 and 50 inches per year, then the blocks should have only minor pits, less than ¼" deep.

If you live in an area where the annual rainfall is greater than 50 inches per year, then your blocks should have no pitting at all, but slight roughening of the surface is to be expected.

For the requirements above, it is assumed that adequate protection from splash exists. This means that either the foundation wall is high enough so the lowest soil layer or blocks do not get splashed, or that the blocks-in the splash region at the bottom are protected.

If your blocks do not meet the requirements above, then you must do something to them if you want a long lasting house. Here are some things that you can try:

1. Change the amount of sand in your soil mix. Sometimes more sand will help. It's worth a try.
2. Try a surface coating. (See Chapter 14.) One of the main reasons for the use of surface coatings is to reduce the amount of erosion due to the feathering simulated by the spray test. When you test a block with the surface coating of your choice, the entire block must be coated even though you will coat only the outside face in the actual building.
3. Try adding one of the stabilizers discussed in the next chapter. Even small amounts of lime, cement or asphalt will often increase the resistance of blocks to spray tests. In fact, you might try anything that you have in the way of waste products. But you should remember that the addition of stabilizers will also change the way the soil acts as far as strength and absorption. For example, small amounts of lime and cement may *decrease* the strength of the soil slightly. So when you try a stabilizer, you must also start all over again with the other tests such as the strength and absorption.

The results of the absorption test are much harder to analyze than those from the spray test. All soil blocks and even burnt clay bricks will absorb some water. (In fact, during recent tests high quality burnt clay bricks absorbed as much water as pressed earth blocks.) For earth houses, you would like to have a soil that will absorb little water, and which will not swell or lose strength during absorption. Unfortunately, this will occur with only a few unstabilized soils. However, by looking at the absorption test on earth blocks in connection with the strength and length changes of the blocks, you will at least be able to tell much more than from the absorption test alone.

Blocks made of clayey soils will take longer to absorb moisture than sandy blocks, but walls made from clay blocks will absorb more moisture over a long period and the moisture will creep higher in the wall. In dry areas - less than 20 inches of rainfall per year - the absorption of blocks can be high and they will still be satisfactory if they are strong enough when wet. On the other hand, blocks which absorb a lot of water will not be suitable in very wet areas even if they are strong. The inside of the house will be much too damp and wet to be comfortable.

Stabilizers can reduce the absorption. Asphalt emulsions do well on sandy blocks. Lime works on clayey blocks

and will also increase the wet strength and reduce the swelling.

*Length changes* during absorption on small test blocks (those less than 6 inches long) should be less than 1/32 inch. On large or full size blocks, allow no more than 1/32 inch for a block one foot long. If this amount is exceeded, it can be reduced by adding stabilizers but again this means that other properties such as strength and absorption must be checked for the new mixture. Adding Sand to clayey blocks will help, and lime and cement also do a good job of reducing the swelling. Unlike blocks which show too much spray loss, those which swell too much cannot be protected by surface coatings.

The water will eventually get through the coating and coating will crack when the blocks start to swell.

*Strength* of your earth blocks is an important factor. Adobe and rammed earth should have a *minimum* dry strength of 250 pounds per square inch. Pressed earth blocks should have a minimum dry strength of 300 psi because they are used in thinner walls. Most soils will be this strong when dry unless they are very sandy or have a lot of organic matter in them. But the wet strength of the blocks after absorption is even more important than the dry strength. Tests have shown that the wet strengths should be at least one-half of the dry strengths. This means that adobe and rammed earth should have a minimum wet strength of 125 pounds per square inch and pressed blocks should have a minimum strength of 150 pounds per square inch.

In dry climates - less than 20 inches of rain per year - you can get by with 100 pounds per square inch for adobe and rammed earth if you use a good surface coating and if the dry strength of your test blocks was high enough.

In wet climates - more than 50 inches of rain per year - you should try to get wet strengths which are close to the ones given above for dry strengths. This means 250 pounds per square inch for adobe and rammed earth and 300 pounds per square inch for pressed blocks.

When the tests are finished, you will have one block left from the original seven. It is a spare in case one of the other blocks breaks. But you can also use it for some special tests.

### **TABLE 3**

#### **SUMMARY OF TESTS ON BLOCKS**

##### **Less than 20 inches rainfall per year**

##### **Between 20 and 50 inches rainfall per year**

##### **Greater than 50 inches rainfall per year**

Spray Test

Pits less than ½-inch deep.

Pits less than ¼-inch deep.

No pitting of surface, alight roughening allowable.

#### Dry Compressive Strength

Minimum of 250 psi for adobe and rammed earth. Minimum of 300 psi for pressed blocks.

Minimum of 250 psi for adobe and rammed earth. Minimum of 300 psi for pressed blocks.

Minimum of 260 psi for adobe and rammed earth. Minimum of 300 psi for pressed blocks.

#### Wet Compressive Strength

Minimum of 100 psi for adobe and rammed earth with good surface coatings, 175 psi without surface coatings.  
Minimum of 150 psi for pressed blocks.

Minimum of 125 psi for adobe and rammed earth. Minimum of 160 psi for pressed blocks.

Beat soils will meet requirements for dry compressive strength. Can be somewhat less.

#### Length Changes

Maximum of 1/32" for 1 foot block.

Maximum of 1/32" for 1 foot block.

Maximum of 1/32" for 1 foot block.

#### Absorption

If you live in an area where it freezes a lot, try this test:

Place your block on the absorption pan for 24 hours. Then remove it and freeze it for 24 hours. Let it thaw on the absorption pan for 24 hours and repeat the process as many times as possible.

If you live in an area where it rains almost daily, try this:

Immerse the block in water halfway up its side for 5 hours. Then let it dry in the sun or in a warm oven. Continue the soaking and drying steps as many times as possible.

Neither of these tests will tell you exactly how long your earth block will last, but they will help you in deciding between several soils that you are thinking of using.

The test results that have been discussed are briefly summarized in Table 3.

## **Chapter 3: Stabilization of soils**

Many kinds of soils can be used for earth walls by adding substances known as **stabilizers**. *Nearly any soil can be made into a better building material with the addition of the CORRECT stabilizer.*

This is what **stabilizers** do:

1. They cement the particles of soil together so the block or wall will be stronger.
2. They can "waterproof" the soil so that it won't absorb water.
3. They can keep the soil from shrinking and swelling.

Adding **stabilizers** - even cheap ones - to your soil means that your house will cost more. But the natural "enemy" of earth walls is water in one form or another. **Stabilizers** fight that enemy. There is less need for **stabilizers** in very dry climates. Builders in arid areas protect against the slow weathering caused by winds and blowing sands by making the walls a little bit thicker. Some walls like this have lasted well over 100 years. It is important to know the experience of other builders before deciding on this method of building.

Because of the many different kinds of soils and the many types of **stabilizers**, there is no one answer that is best in all cases.

All this manual can do is tell you what **stabilizers** can be used, which ones work best on different kinds of soils, and approximately how much stabilizer seems to work best. It is up to the builder to make trial blocks with various kinds and amounts of **stabilizers** and then, test them as described in Chapter 2.

### **Kinds of Stabilizers**

Here are the more commonly used **stabilizers**:

1. *Sand and clay* - Usually we think of soil **stabilizers** as something unusual and different, but ordinary sand and clay can also be used as **stabilizers**. If your soil is too sandy, then add a little clay to it, or add sand to a clayey soil. It's true with all **stabilizers** - and sand and clay are no different - that they must be mixed thoroughly into the soil before they can do the job. If you have one soil that is very sandy, and another that is very clayey, they probably won't mix very well because the clay lumps cannot be easily pulverized. The only way to find out whether two soils will mix well is to try it. It's easier to mix a small amount than a large amount, so try to do the mixing just as you would when building a house.

2. *Portland Cement* - The same kind of portland cement used in concrete is also one of the best soil **stabilizers**. The mixture is often called *soil-cement*. Cement works best with the sandier soils. Table 1 shows you which soils are stabilized best with cement. (If your soil has been checked by the laboratory tests described in Appendix A, you can use portland cement with any soil that has a plasticity index from 0 to about 12.)

Some **stabilizers** mix easily with soil but this is not true of portland cement. It must be very thoroughly mixed and the soil clods should be broken down so the cement comes in contact with all of the soil. (This is one reason why cement is not recommended for clayey soils.)

Cement starts to react as soon as it touches water, so do not mix it into wet soils. Mix it completely into dry soils before adding water. Then, the moist soil-cement mixture should be formed into blocks or rammed in the wall quickly. If you wait too long before doing this, the soil-cement will harden and it must be thrown away. Don't mix more than you intend to use.

Cement needs water to get hard. Since it gains most of its hardness or strength in 7 days, you need to keep it moist this long. One way to do this is to put a watertight cover over the blocks or walls. If you cannot do this, cover them with wet burlap sacks and sprinkle the sacks often. After 7 days of this moist curing you can take the covering off but it is still a good idea to keep the blocks in the shade for another 7 days before you let them dry in the sun. *The longer you keep your soil-cement blocks or walk moist, the stronger they will be.*

Using cement has two disadvantages: it is expensive and it may be hard to get. So try to find out first how little you have to use.

You can make a portland cement yourself. To do it, though, takes a lot of heat, some crushing facilities, a source of clay, and a source of limey material such as &hells, limestone, caliche, etc.

3. *Lime* - Lime, either slaked or unslaked, makes one of the best stabilizers for clays. Lime reacts with the clay in the soil to form a binder. Unslaked lime is harmful to a person's &kin and vital parts and must be used with great care. It is much safer to first slake the unslaked lime before using it. Table I shows the soils which work best with lime. If you use the more exact laboratory tests described in Appendix A, you can try lime with nearly any soil having a plasticity index greater than about 12.

Lime makes most clays less sticky, but it doesn't make all of them stronger. It will usually strengthen volcanic clays, but with any other clayey &soils, the only thing to do is try the lime out and see how it works. Use the tests in Chapter 2.

Soils containing a lot of clay are usually fairly lumpy. But lime breaks the lumps down and makes the soil easier to mix. In fact, lime even makes the soil look and feel different. If your soil has a lot of clay in it, here's what you should do:

Add the lime to dry soil and mix with sufficient water to dampen entire mixture, then cover it for a day or two but keep it wet. After you do this mix the soil again to break down any remaining lumps and use it right away.

Lime also needs to be kept moist to gain its strength but it takes much longer than cement to harden. Keep lime-stabilized blocks covered and moist at least 7 days, 14 days if possible. Then keep them in the shade at least 7 more days before exposing them to the sun. When making trial blocks with lime-stabilized soils, try to make them early enough that they will have plenty of time to cure before testing. At least one month of curing is necessary, two months are better.

Lime is not as expensive as cement and you can get it nearly any place in the world. You can make lime yourself but it's not an easy job. You'll need heat and a material such as limestone, seashells or caliche, and finally a way to grind up the burnt limestone.

It takes lime-stabilized soils about 6 times as long to get their full strength as it does soil-cement. Remember this when you are trying to compare lime and cement stabilized soils.

4. *Combinations of Lime and Cement* - Sometimes you'll run into a situation like this:

The soil has a little too much clay in it for cement to do a good job of stabilizing.

Lime will make the soil easy to work, but it won't react enough with the soil to waterproof it or make it strong.

When this happens, you can use both lime and cement. It will cost more and take more time to add the two stabilizers, but it may be the only way to build your house.

Usually, equal parts of lime and cement are used. The lime is *always added first*. Then, add enough water to

make the mix moist. Cover the mix and let it stand for 1 to 2 days. -After this mix the soil well to break up any lumps and immediately add the cement plus any water necessary to bring the soil to its correct water content. After thorough mixing, use the stabilized soil immediately, before the cement hardens. Cure it as you would cement.

5. *Asphalt* - Another stabilizer that has worked out well for earth houses is asphalt. Asphalts made especially for use in earth houses are made in plants in the United States, but they don't have to be a special kind. Natural asphalts were used thousands of years ago to stabilize earth blocks in Babylon. Asphalt is usually restricted to those soils that are mixed by "puddling," such as adobe. It is harder to mix into moist soils used for pressed blocks or rammed earth. It won't work on clayey soils because it won't mix with them.

Asphalt in its natural form is too thick to be added to soils without heating, so they are often mixed with other materials to make them thinner and easier to mix. If they are mixed with water they are called asphalt *emulsions*. These are the best to use in earth walls because there is no danger in handling them and they mix easily into the soil. After asphalt emulsions have been added to the soil they will separate back into pure asphalt and water - leaving the asphalt as a film on the soil grains. One that goes back to asphalt and water quickly is called a "fast-breaking" or "fast-setting" emulsion. These are not good for earth houses because they may separate before they are completely mixed into the soil. "Slow-setting" or "slow-breaking" types are ideal for earth houses. (If you cannot find an emulsion made especially for earth houses, then get a regular emulsion, but make sure it's the "slow-setting" or "slow-breaking" type.)

Other types of asphalt that have been used are called "cutback" asphalts. These are asphalts that have been mixed with gasoline, kerosene, etc., to make them thinner so they can be mixed without heating them. They can be used with soil but they are not as good as emulsions. After a soil is treated with a cutback asphalt, it must be spread out to allow most of the gasoline or kerosene to evaporate before it can be made into blocks. Cutback asphalts can catch fire if you get them near an open flame.

Since asphalt is really a very thick oil, it will "grease" the soil grains and cause the soil to lose some of its dry strength, at least until the stabilized soil becomes a few years old and the asphalt hardens. Asphalts do a good job of waterproofing the grains, and they keep the soil from losing strength when wet.

Remember, asphalt will be very difficult to use when the soil has a lot of clay in it. It works out best with soils suitable for adobe blocks.

6. *Straw* - A material that has often been used in adobe blocks is straw. In the same manner, materials such as tree bark, wood shavings, hemp and other tough fibers have been used. The only one of these that has appeared to be of much use is straw - although some people have had fair success with wood shavings.

Straw doesn't react with the soil in any manner. If anything, it will make the dry block a little weaker and it will let it absorb water a little easier. Straw does provide "pipes" or exits from the inside of the block so the water can get out easier during the curing period. In clayey soils especially, this causes less cracking during curing. Straw or other fibers also give added strength to wet adobe blocks during the curing period.

Although most old adobe houses contain straw in the blocks, modern builders do not use it. It may have some value when your soil is a little too clayey and you have no other way of stabilizing it.

7. *Fly-Ash and Lime Combinations* - Fly-ash is the fine dust that is given off during the burning of coal, coke, lignite, and some other solid fuels. If you live near a plant that burns these fuels and saves the fly-ash, you have a very good cheap stabilizer if you have lime to mix with it. The lime and fly-ash together will make a cement almost as good as portland cement. It can be used on both sandy and clayey soils.

When using lime and fly-ash together, use about 2 to 4 times as much fly-ash as lime. For example, for every



bucket of lime used, add between 2 to 4 buckets of fly-ash. The only way to find out whether you should use 2 buckets or 4 buckets, or something in between, is to make some trial blocks and test them. You'll probably find that lime is more expensive than fly-ash so try to use as much fly-ash as possible and still make a satisfactory earth wall.

8. *Sodium silicate* - This is-sometimes called "water-glass." It is available in many parts of the world and not expensive when bought in large quantities. It works best on sandy soils such as clayey sands and silty sands. Clays do not stabilize well with it.

The best way to use sodium silicate is to coat the outside of earth blocks with it so it makes a thin "skin" of hard, stabilized soil around the blocks. (For use on walls that are not made of blocks - such as rammed earth - see Chapter 14.) To use it, mix one part of commercial sodium silicate with three parts of clean water. Dip the earth blocks in the solution for about one minute. When you remove them there will be a little solution left on the blocks. Use a stiff brush to brush this into the block. Repeat this treatment a second-time before the blocks dry. Then, let the blocks air-dry in a protected place at least 7 days before using them.

The thick solution of water and sodium silicate can be made to penetrate deeper into the blocks if you add a very small amount of a group of chemicals known as surfactants (surface active agent). These chemicals numbering over 1500 are sometimes classed into four groups called amphoteric, anionic, cationic and non-ionic. These groups include such chemicals as polyoxyethylenealkylarylether and dodecylbenzenesulfonic, amines, etc.; however, many common detergents will work as well as these chemicals.

There are many other stabilizers that have been used successfully with some soils. Because there has been little written about their use in earth houses they are discussed only briefly below. But, don't be afraid to try them out if they are available. In fact, if you have something else that you think will be a good stabilizer, try it. Sometimes a waste product that other people are throwing away may be a good stabilizer.

9. *Sulfite Liquor* - This is a waste product from certain paper mills. It is primarily a waterproofing agent and you shouldn't expect it to increase the dry strength of the soil. Some types of sulfite liquors react very favorably with soils, others have a very harmful effect on them. You won't know until you try it out on your soil. The amount of sulfite liquor you should use depends on the particular paper mill you get it from, so you will have to try different amounts and select the best one yourself.

10. *Aliquat H226* - A special chemical, (quaternary amine), made in the United States but available in other parts of the world. It is shipped as a very thick liquid and it must be mixed with warm water before it can be added to soils. The manufacturer will give you instructions on how to use it. Although it is expensive, it is a good waterproofer for silts and clays once the treated soil has been allowed to air-dry. It would be very good for use in the first few layers of earth blocks closest to the ground if these blocks didn't pass the requirements of the absorption test.

11. *Wood ashes* - In some countries, wood ashes have made very successful soil stabilizers. Probably it is the lime or calcium in them that actually does the stabilizing. Like sulfite liquor, certain wood ashes can actually be harmful instead of stabilizing the soil, so you will want to try it out on your soil. The correct amount to use will vary depending on the type of wood and how well it has been burned. The fine, white ashes from fully burned hardwood seem to work best.

12. *Resins* - These are made from the sap of trees. They can make very good waterproofing agents, but they probably will not add much dry strength to the soil. Some are difficult to apply to the soil because they will not dissolve in water. It is best to ask the manufacturers of the various resins how they should be applied.

13. *Coconut Oil* - This has also been used as a waterproofing agent. There is no cementing action but it will probably increase the wet strength of the soil.

14. *Tannic Acid.*
15. *Rotted Plantain Leaves.*
16. *Cattle Urine.*
17. *Cow Dung.*
18. *Molasses.*
19. *Gum Arabic.*
20. *Juice from Various Plants.*

### **How do you know whether a stabilizer will work?**

Because there are so many different kinds of soils, it is impossible to say whether any one stabilizer will work well on any particular soil. In Table I and in the early part of this chapter; you have been given some idea of what type of stabilizer to use with what type of soil. But the only way to find out what is best is to try them out on your soil. Make trial blocks and test them just as you were told to do in Chapter 2. Don't use expensive stabilizers if cheap ones are available and your tests show that they will do the job.

### **What can you expect stabilizers to do?**

You want stabilizers to increase both the dry and wet strengths of your soil; to reduce the amount of water absorption, and to keep your soil from being "melted" by a water spray or rain. Some stabilizers will do only one or two of these things, a few may do all of them.

For example, portland cement or lime may not decrease the water absorption, but it wouldn't make much difference if the wet strength of the block was high.

Some waterproofing type stabilizers may actually decrease the dry strength of the soil, but will greatly increase the wet strength and decrease the amount of water absorption. Naturally, then, these might be best in wet climates.

Certain stabilizers - lime is a good example - may actually cause a pressed or rammed earth block to weigh a little less. Don't let this bother you though because it won't hurt the strength of the soil.

Some stabilizers - lime again is a good example - will change the best moisture content for compaction. Lime stabilized soils usually need more water than the same soil unstabilized. You probably wouldn't notice this unless you accurately measured the amount of water needed. You can still use the simple test described elsewhere to determine whether stabilized soils for rammed earth and pressed blocks have the right amount of water in them to make the best blocks.

### **Do stabilized soils require special handling?**

Some types of stabilizers require special handling or they won't work at all. Remember it was mentioned earlier in this chapter that portland cement and lime needed to be moist-cured for at least 7 days or they wouldn't gain

strength. This is true of nearly all cementing stabilizers.

Most waterproofing stabilizers only work after the soils have been dried out once. This won't require special attention because you dry the soils out when you cure them in the sun, anyway.

With many stabilizers, the curing takes place after the blocks have been molded. But with asphalt emulsions, at least some of the curing has to be done while the soil is still loose *unless you are making adobe blocks*. For rammed earth and pressed blocks, spread the stabilized soil out in the sun to cure. There is no good rule to tell you when you can start using these soils and you will have to find out yourself by experience. If you can ram or press the soil and it doesn't act spongy or heave around the sides of your rammed earth tamper, it should be ready to use.

Cutback asphalts - those containing kerosene, gasoline, etc., are slow in curing. It might take several days before they are ready to be made into blocks or an earth wall.

NO STABILIZER IS GOOD UNLESS IT CONTACTS EACH PARTICLE OF SOIL. MIX THEM INTO THE SOIL WELL.

### **How much stabilizer should you use?**

Again, it is impossible to say with any accuracy just how much should be used. It depends on the type of soil you have and what you want the stabilizer to do.

Sometimes you will need a lot of stabilizer - particularly with very sandy or very clayey soils.

You might find a soil that is suitable in all ways except that it doesn't meet one requirement, for example, it absorbs too much water. Then, probably a very small amount of a stabilizer will be needed. A soil that is not good enough to meet any requirements or maybe only one of them will require more stabilizer.

So, you can see that the only way to find out how much stabilizer is necessary is to make some trial blocks and test them. You should make up three trial sets of seven blocks each. If you use portland cement, trial amounts should range from 4 to 12 percent and for lime 2 to 6 percent.

EACH TRIAL SET SHOULD CONTAIN A DIFFERENT AMOUNT OF STABILIZER, RANGING FROM ABOUT- THE LOWEST THAT MIGHT WORK TO THE LARGEST AMOUNT YOU COULD POSSIBLY AFFORD TO BUY. TEST THESE TRIAL BLOCKS AND SELECT THE LOWEST AMOUNT OF STABILIZER THAT WILL MAKE YOUR BLOCKS GOOD ENOUGH TO SATISFY THE REQUIREMENTS IN TABLE 3.

When you have finally selected the exact amount of stabilizer that you need, there is one more thing to consider. With trial blocks, you use a small amount of soil and it is easy to do a good mixing job. During the actual construction of your earth house, the workers will handle much larger quantities of soil and the mixing will not be as good. The easiest way to take care of this is to add a little more stabilizer.

All of this sounds, we realize, like a great deal of preparation and testing that needs to be done. That's the way it is intended to sound. It will be well worth your time and effort to find out for yourself what the best answers will be for you. If it takes you a couple months of preparation, remember, it's worth it. If you do your job right, your grandchildren will also have a good house to live in.

## **Chapter 4: Where to build**

The home builder needs a good place to build. The lot should be big enough not only for the house but also for a yard and a garden. Plenty of suitable soil must be available either on the property or nearby. Other factors are important, too:

The lot has to have good drainage. Standing water or muddy ground can be very destructive to earth houses. If water stands on the area after heavy rains, the lot will not be satisfactory unless trenches or ditches can be dug to carry the water away rapidly. Figure 19a shows a good site and Figure 19b a bad one.

The location of the home should also be convenient to roads, markets, or the owner's job.

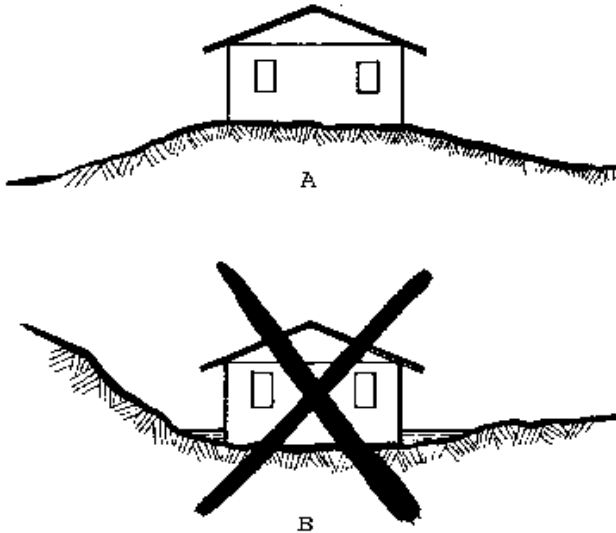

Figure 19.

Usually, old home sites work out well because the soil has stabilized itself or settled under the weight of the old house.

**LEVELING -THE LOT** - Clear the site of unwanted brush and vegetation before beginning construction. All vegetation and the organic top soil should be removed from the area the house will occupy. All spongy or soft material should be removed down to good, firm soil. Leave enough extra space outside the limits of the house for a working area. Save plants which will have ornamental value after the home is built.

After the location of the house is marked on the ground, mark the outlines of the house with stringlines nailed on stakes. Then level the ground inside the stringlines. This is shown in Figure 20. Low areas may be filled in from adjacent high areas, provided good soil, which will not wash away, is used. *Any fill material placed inside of the string lines should be well pounded with a hand tamper to make a solid foundation.* Otherwise, settlement of the fill material could cause cracks in the house. Extra dirt from the leveling job is kept for later use if it is the kind suitable for building.

**FINDING THE GROUND LEVEL** - Before laying out the actual outlines of the house, the general area it will occupy should be fairly well graded or leveled and an accurate floor level should be marked out carefully.

This is done easiest by driving stakes into the ground. First, drive a stake to the desired floor level. Protect it by surrounding it with other stakes. Then, drive in other stakes around the approximate outlines of the house to exactly the same floor level. This can be done in two ways.

To find the correct height of the additional stakes, if possible, a surveyor's level should be used and the tops of all the stakes can be accurately sighted. (For convenience, if the surveyor's level is used, make the tops of the stakes somewhat higher than floor level and later measure down from each stake to the desired floor level.)

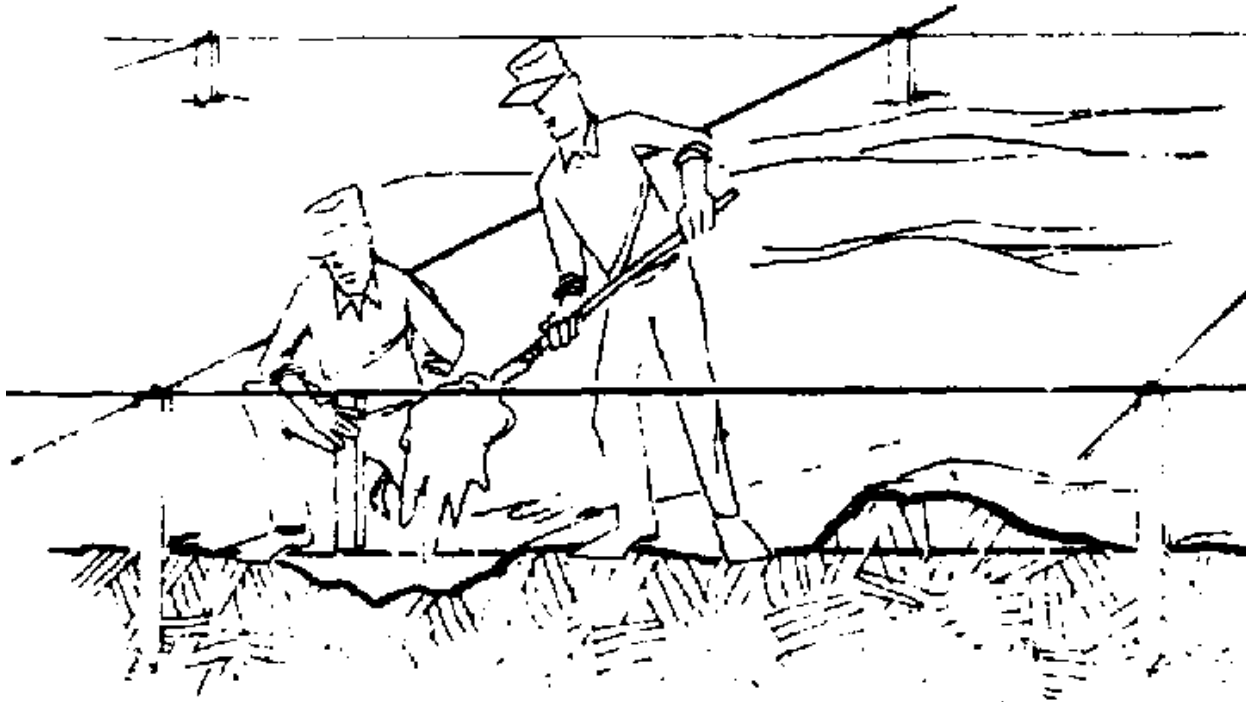

Figure 20.

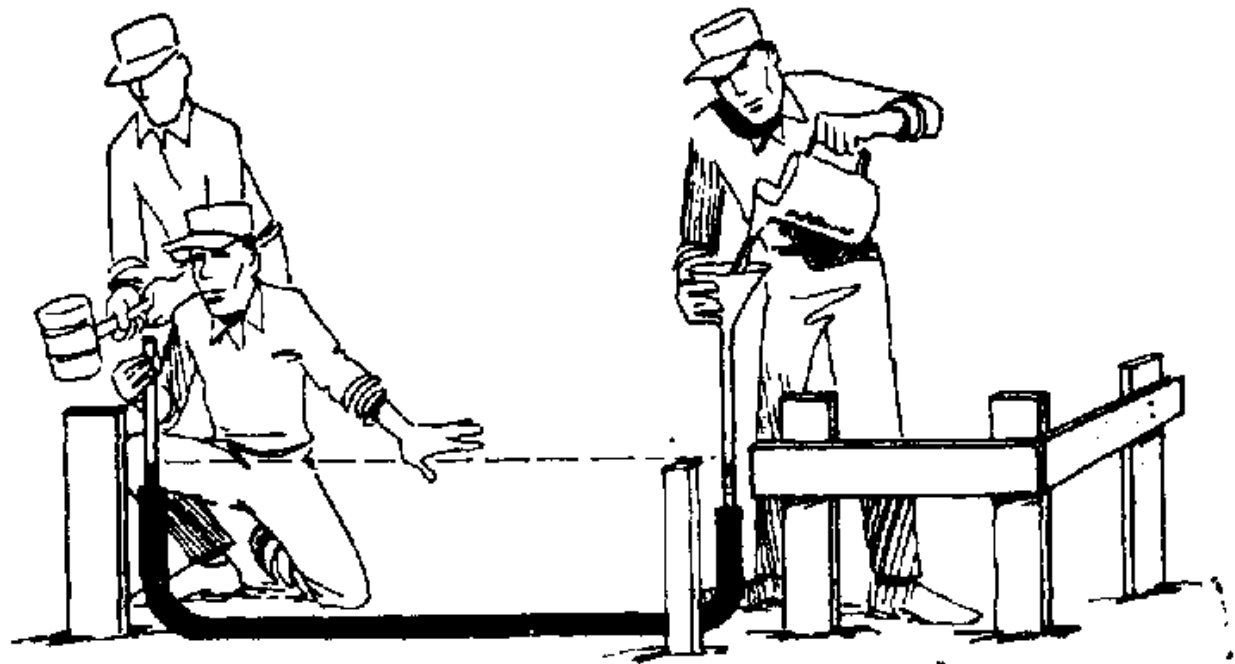

Figure 21.

If a surveyor's level is not available, an ordinary clear or translucent plastic water hose will work just as well. Fill

all but about a foot of the hose with water.

By adjusting the water level at one end of the hose to the exact floor level indicated by the first guide stake, then all of the other stakes may be driven to the proper level by matching the tops of those stakes with the water level at the other end of the hose. The water hose method is shown in Figure 21.

By driving the first stake into the ground at what you judge to be the highest point of your lot, all of the other stakes, then, will stick out of the ground a little higher. If it turns out that the guide stake is lower than the ground level at other stake points, drive another stake next to the guide stake leaving enough length above the ground for later measurements. For example, have this added stake exactly one foot higher than the guide stake. Then drive the other stakes to match it. The desired level can be determined by measuring one foot down from the tops of these stakes or to such level as to have the lowest corner above grade.

The water hose also can be useful at other times during construction. It can be used as an accurate means of finding other levels or elevations. It is useful in finding the correct height of footings and foundation walls, checking to see that blocks are being laid level or even checking the top layer of blocks before the roof is placed.

It is a good idea to have corks or plugs to stop up the ends of the hose to keep the water from running out when the hose is not being used.

*LAYOUT OF THE CONSTRUCTION* - The next step is to mark the exact location of the exterior walls on the ground.

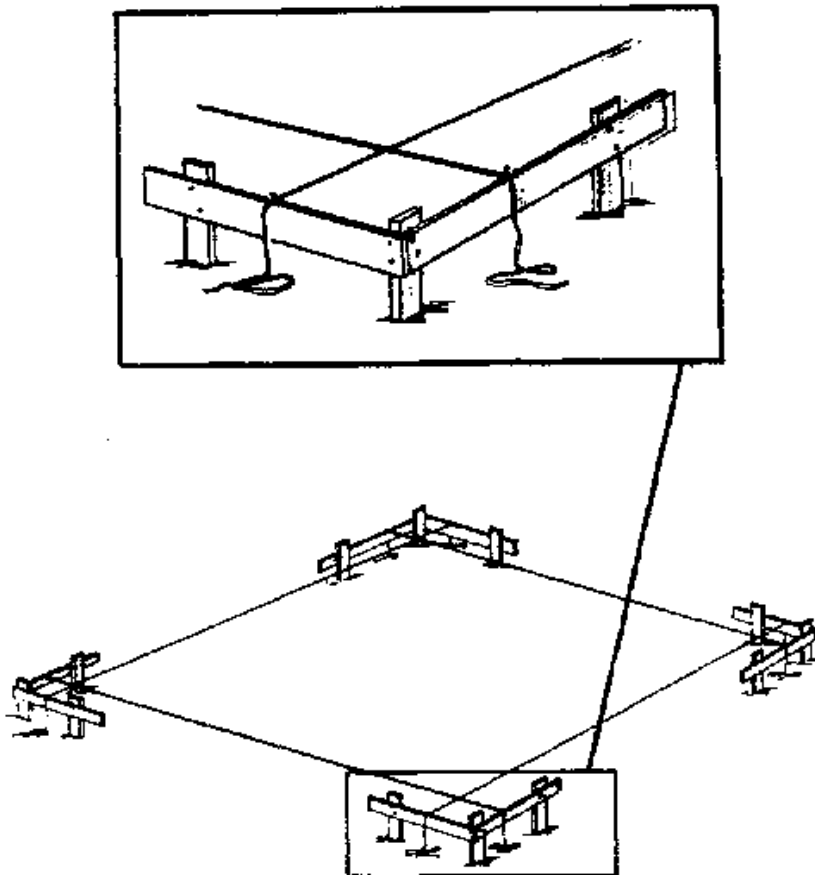

Figure 22.

The proper dimensions and shape are included in the house plans. Keep in mind which way you want your home to face. An architect can be very helpful. Consider such things as prevailing breezes, direction of sun, appearance, distance from street and property lines, etc.

After the location has been selected, the next step is to erect batter boards. These boards, Figure 22, should be at least 5 feet long so that adjustments can be made after they are placed in the ground. A set of batter boards should be placed at each corner of the exterior walls of the house. The batter board at the corner where the ground is the highest should be set about 18 inches above the ground. Those at the other corners should be set at the same level (in other words they will be higher above the ground). They must be sturdy enough to hold the tight string lines which will be stretched from them to define the walls of the house.

Square corners can be made and checked simply.

To make a square, take three boards, exactly 3, 4 and 5 units long and nail the ends together as shown in Figure 23a.

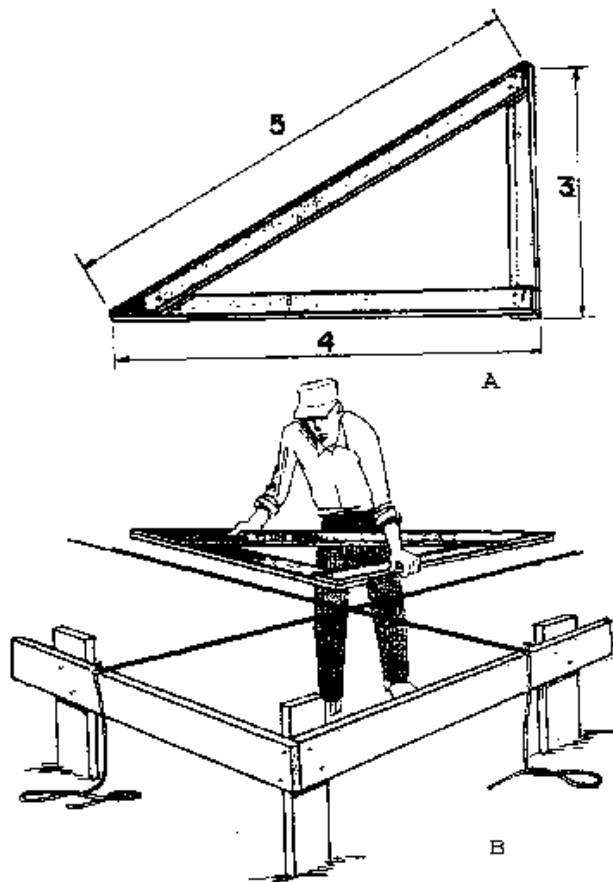

Figure 23 (23a; 23b).

The angle between the 3-unit and the 4-unit boards will be 90 degrees or a "square" angle. By aligning the strings along these two boards as in Figure 23b, two sides of the house can be properly positioned.

To begin the layout of the house, a stake should be driven about three feet inside one set of batter boards to form the first exterior corner. The right angle of the square is then located properly at this stake and all measurements begin from here. The stake would be placed just below where the strings cross in Figure 23b.

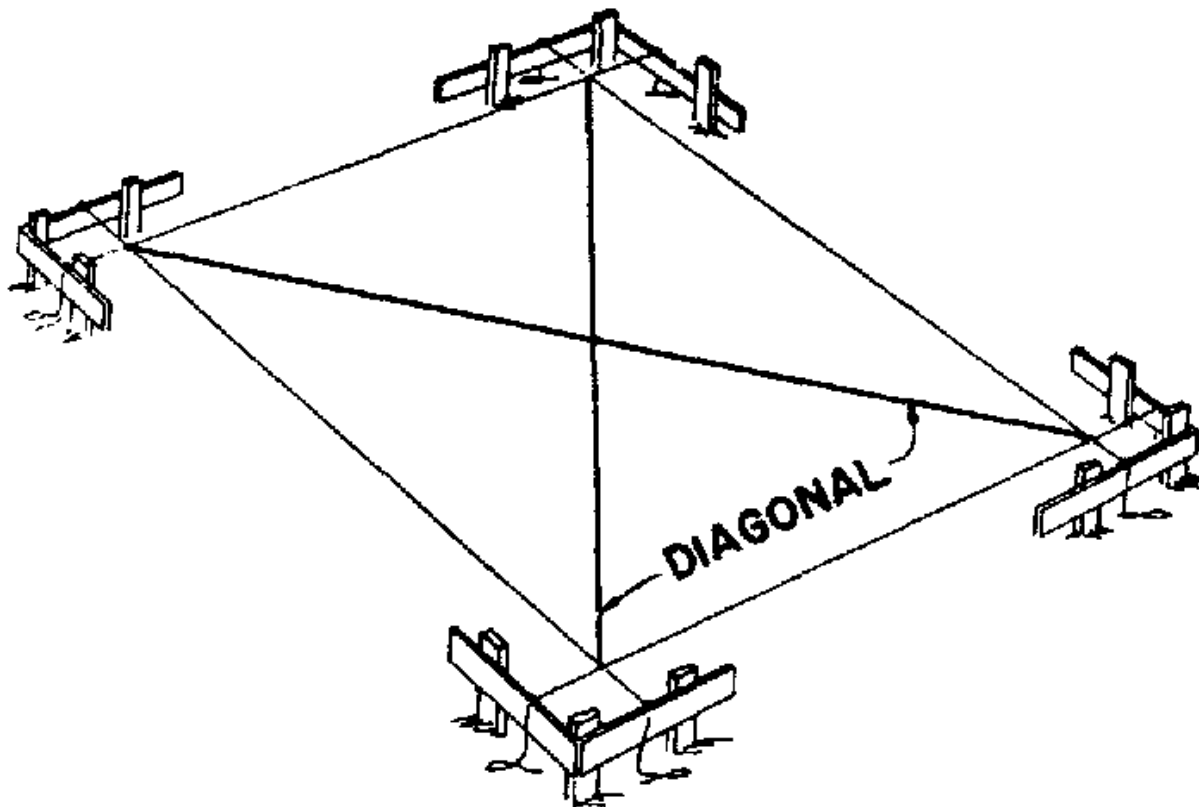

Figure 24.

String lines are then stretched between batter boards to mark the direction and length of sides of the walls. This procedure of measuring and laying out square corners is continued around the outline of the house until the task has progressed back to the starting point.

If the house outline is in the shape of a square or a rectangle, the alignment can be checked by measuring the diagonals - the length between opposite corners. If the outline has been properly laid out, and the corner angles are square, the length of the two diagonals will be exactly the same. If these lengths are not equal, adjustments should be made until they are by moving the positions of the strings on the batter boards. These diagonals are shown as heavy lines in Figure 24.

Even when a square is not available, an accurate layout can be made. To do this, mark off two corners of the house at the proper distance apart to establish a side of the house in the desired direction. Then, as closely as you can estimate their positions, lay out with strings the two sides that lead from the first side you have established. These sides should be of proper length. When this has been done, check the diagonals. If they are not exactly equal, the last two corners should be moved until the diagonals match each other. This will assure an accurate square or rectangle.

It is best to use more than one set of string lines to mark the dimensions of the building. The first set of lines marks the location of the outside edge of the walls of the building. However, the limits of the excavation for the footings (which are discussed in the next chapter) and foundation wall will usually be outside of the location of the walls. In this case, additional string lines are placed on the outside of the first set to mark the limits of the hole to be dug.

Once the string lines for the excavation have been placed, the limits of the excavation should be properly marked on the ground so the workmen will dig along the proper lines. This can be done by driving guide stakes directly



beneath the string lines marking the excavation, or by spreading a thin line of lime beneath the string lines. In either case, the string lines should be removed during the excavation so they will not be broken by the workmen. Be sure to mark the location of the string lines on the batter boards so they can be put back in exactly the same place after the excavation is complete.

*DRAINAGE* - If the house is to be built on nearly flat ground, the drainage of the lot away from the house should now be considered. Any lines of wash, or gullies that cross the construction site should be turned away by digging new ditches away from the house and filling in the ditches with tamped soil. It is also important that the ground level next to the building be higher than the rest of the lot so that water will drain away from the building. A canal or ditch several feet away from the foundation may be necessary to carry away excess water during heavy rainfall.

## **Chapter 5: Foundations**

The foundation is that part of the house that is built below the ground surface and supports the house. A properly built foundation will keep the house from being damaged or twisted out of shape due to settlement of the earth, high winds, or frost action. A good house must have a good foundation; it is the most important part of the house.

*TYPES OF FOUNDATIONS* - House foundations may consist of separate *piers or footings*, which receive the load of the house through heavy beams that rest on them, or they may be *continuous footings* that run under all outside walls and load-bearing partitions. For earth walls, continuous footings are most commonly used. A *foundation wall* rests on the footing and extends upward and supports the walls. A typical continuous footing and foundation wall is shown in Figure 25. Not all such construction requires reinforcing steel.

*FOOTINGS* - Footings have three purposes: (1) to provide a solid, level base for the foundation walls; (2) to hold the weight of the house it supports on the earth so that the load will not be too great at any point for the soil to support; (3) to resist the "lifting" forces of hurricane or high winds which can tip a house over or move it off of its foundation.

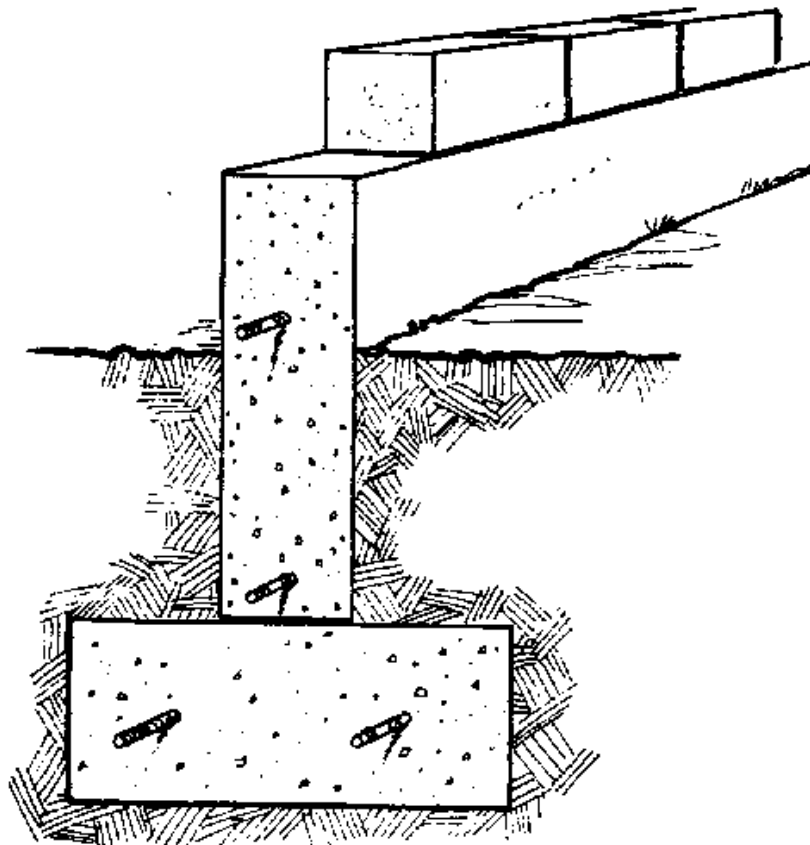

Figure 25.

The size and depth of footings depend on: the type of material used to make them; the weight they must support; the load the soil will support, and, to some extent, the weather conditions of the area.

*DEPTH OF FOOTINGS* - In areas where freezing weather occurs, footings must be placed in the ground at least as deep as frost is ever found. Otherwise, the footing will shift and crack the house during or after freezes. The frost line is shown in Figures 26a and 26b as a heavy dash line. Figure 26b shows what can happen if the footing is too shallow. If no other means of knowing this depth is available, it can be roughly estimated on the basis of the resistance to digging during particularly long and severe winters. Ice particles can be seen in the soil. The footing should be placed below where ice is found.

In warmer climates, the footing depth needs to extend deep enough to reach good, solid earth free from vegetation (roots, etc.) and deep enough to prevent washing out or shifting due to rain and flooding. Usually, this depth averages from 12 to 18 inches. An exception to this is where the soil shows considerable shrinking and swelling as it dries and becomes wet during the year. If this is the case, the footing should extend to a depth where seasonal changes in moisture are minor. Sometimes this can be estimated by the appearance of the soil. The soil is usually very crumbly in the area where the moisture changes seasonally and it takes on a more solid appearance below this depth.

The best and easiest way to find out the proper depth of footing is to see what depth was used for similar houses in your area. If the houses are holding up well and have not settled or cracked, the footing depth used for them will do for your house. If you have any doubt, go deeper.

*SIZE OF FOOTING* - The size of the footing will depend upon the strength of the soil and the weight of the house. As a general rule, most shallow clays and shallow silty soils should not be loaded above 2,000 pounds per square foot of footing area. Firm sandy and gravelly soils may carry from 4,000 pounds to 6,000 pounds per square foot.

If there is any question about the value of the soil, a loading test should be performed. A simple loading test is described in Appendix A. Use it if you can. If you can't, then the strength of the soil can be very generally estimated using the 'simple strength test' given in Appendix A.

Once the bearing value or strength of the soil is known, and the weight of the house has been determined, the width and thickness of the footing can be easily determined from Table 4. The dimensions given in Table 4 can be varied somewhat depending on local experience but do not reduce any satisfactory values you find. The building in Figure 27 shows the effect on an earth wall of an under-designed foundation.

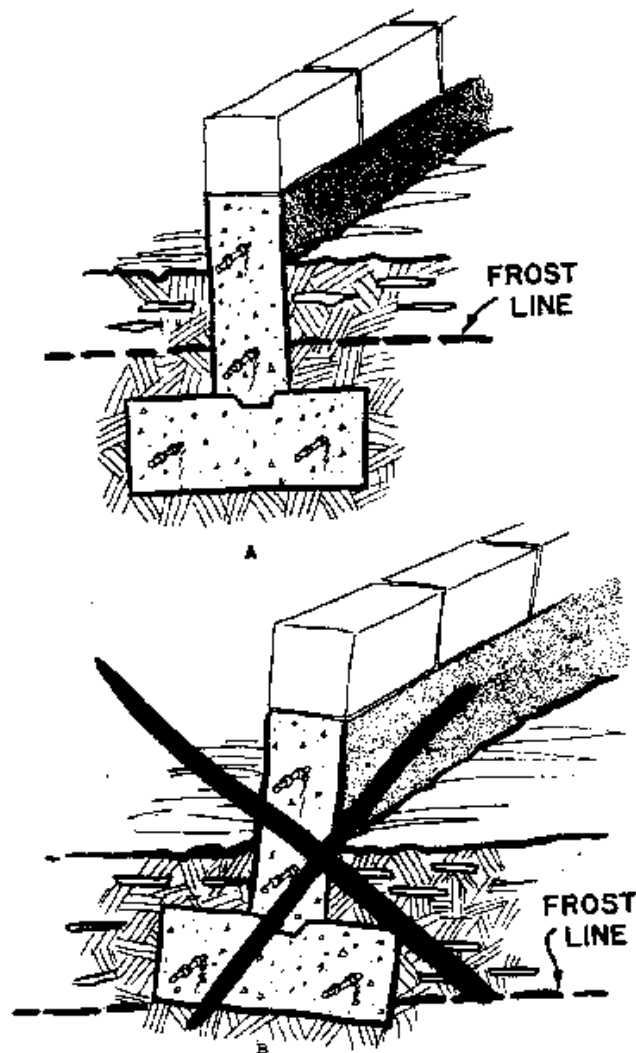

Figure 26.

*MATERIALS FOR THE FOOTINGS* - Since the footings are buried in the soil, they should consist of materials that cannot be damaged by decay or insect attacks. Use concrete, stone, brick, concrete block and similar materials. Recently, some footings have been made with stabilized soil. However, they have not been in place

long enough to determine how suitable they might be. On the basis of what is now known, it is better to avoid the use of stabilized soil for footings except in arid or semi-arid regions.

**CONCRETE FOOTINGS** - Footings made from poured concrete are the most popular type because they are easy to make and work very well; however, they will probably be the most expensive type. Usually forms are not needed: as a trench can be dug to the correct depth and width of the footing and the concrete can be poured directly into the trench to form the required footing thickness. (See Figure 28.) If the soil is sandy or tends to slide or cave in, then simple forms are required to insure that the footings are wide enough and that the soil does not fall in the freshly poured concrete. These forms may consist of boards with width equal to the thickness of the footing and held in place by enough wooden stakes to keep the boards from moving or bowing. *The forms should always be removed, but not earlier than 48 hours after the concrete has been poured.* It is best to cure the concrete for several days by covering it with wet sacks, leaves, etc.

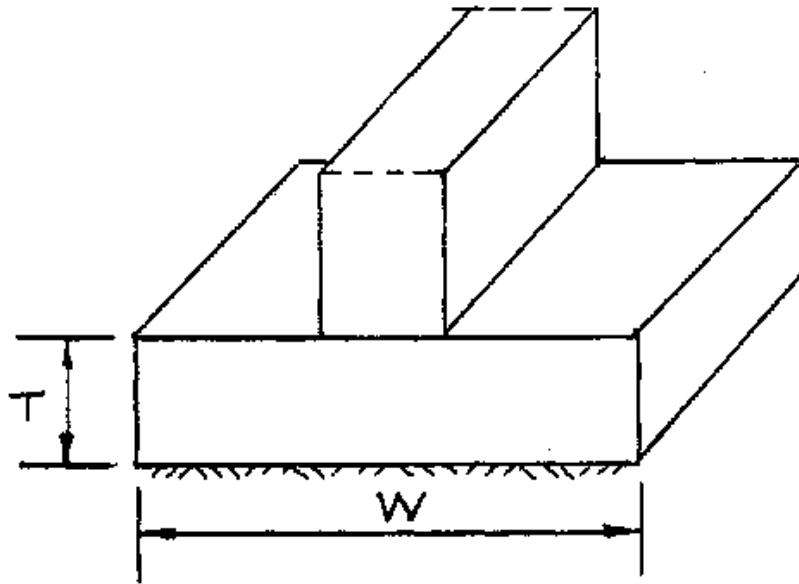

Figure (See Table 4.)

**TABLE 4**

**FOOTING WIDTHS AND THICKNESSES FOR CLAY FOUNDATION SOILS**

**IF SOIL STRENGTH IS**

**A**

**B**

**C**

**D**

**E**

**F**

**USE W AND T**

**W**

**T**

**W**

**T**

**W**

**T**

**W**

**T**

**W**

**T**

**W**

**T**

Kind of House

One Story - 6 inch thick walls - Light Roof

18"

7"

12"

1/8"

12"

8"

12"

8"

12"

8"

12"

8"

One Stow - 6 inch thick walls - Earth Roof

27"

8"

15"

9"

12"

10"

12"

10"

12"

10"

12"

10"

One Story - 9 inch thick walls- Light Roof

One Story - 9 inch thick walls - Earth Roof

36"

18"

18"

9"

12"

11"

12"

11"

12"

11"

12"

11"

One Stair - 12 inch thick walls - Light Roof

One Story - 12 inch thick walls - Earth Roof

36"

18"

18"

10"

12"

12"

12"

12"

12"

12"

12"

12"

One Story - 15 inch thick walls - Light Roof

36"

8½"

21"

10"

15"

12"



15"

12"

15"

12"

15"

12"

One Story - 15 inch thick wall - Earth Roof

86"

9"

24"

10"

18"

11"

15"

12"

15"

12"

15"

12.

Two Story - 9 inch & 6 inch walls - Light Roof

36"

9"

24"

10"

18"

11"

15"

12"

15"

12"

15"

12"

Two Story - 9 inch & 6 inch wall - Earth Roof

No\*

27"

9"

21"

11"

18"

12"

15"

12"

12"

12"

Two Story - 12 inch & 9 inch walls - Light Roof

No

30"

9"

24"

10"

18"

12"

15"

18"

15"

13"

Two Story - 12 inch & 9 inch walls - Earth Roof

No

33"

9"

24"

11"

21"

11"

18"

12"

15"

13"

Two Story - 15 inch & 12 inch walls - Light Roof

No

36"

10"

27"

11"

24"

12"

18"

13"

18"

13"

Two Story - 16 inch & 12 inch walls - Earth Roof

No

No\*

30"

10"

27"

11"

21"

13"

18"

14"

Two Story - 18 inch & 16 inch walls - Light Roof

No

No

36"

11"

30"

12"

24"

13"

21"

14"

Two Story - 18 inch & 16 inch walls - Earth Roof

No

No

36"

11"

33"

12"

27"

13"

24"

13"

\* Do Not Build on Foundation Soil This Soft.

When digging for footings it is always better to dig on the "safe" side; that is, too deep, rather than too shallow. If the excavation is too deep it can be filled with extra concrete, sand or earth, but the sand and earth must be *tamped* in and not just loosely placed.

Concrete footings do not always require reinforcing steel but it is better to have them lightly reinforced to resist cracking that occurs with changes in temperature. Conditions where reinforcing is considered absolutely necessary include occasional "soft" spots in the bottom of the trench, and areas subject to earthquakes, hurricanes, or swelling of the soil. Reinforcing is also needed if the footing projects beyond the foundation wall more than  $\frac{2}{3}$  of its thickness. In these cases, it is desirable to seek the services of an engineer or architect for advice concerning the kind, size and location of reinforcement.

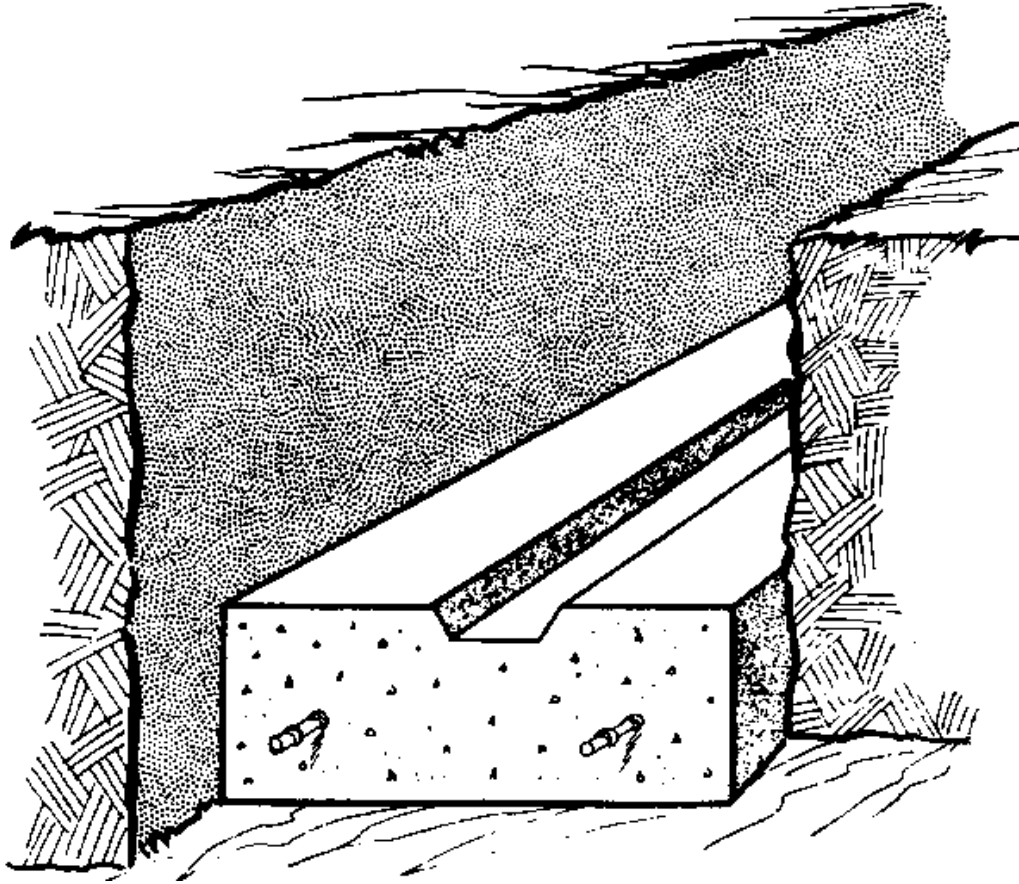

Figure 28.

The concrete for the footing should have enough water to be workable but at the same time it should not be so wet that the mortar tends to flow away and leave only the larger rocks. A good concrete mix for the footing uses:

1 part portland cement

3 parts clean washed sand

4 parts clean gravel

about 5 to 7 gallons of water for every 94 pound bag of cement

A good way to estimate whether or not you have the correct moisture is to place some of the mix in a bucket and rod it about 25 times with a smooth steel or wood rod. Then from a height of 6 inches above the surface, drop a smooth round rock about 4 inches in diameter into the mix. If it dents the mix about 1½ inches, the water content of the concrete is about right.

If reinforcing rods are used, they are placed in the excavation and *securely supported* at the proper height before the concrete is poured. The top finish of the footing is left very rough to provide a good bond for the foundation wall. It is usually a good idea to leave a small channel or groove in the center of the footing as shown in Figure 28 to provide additional bond between the footing and the foundation wall if the footing is made of concrete. If at all possible in earthquake areas, short lengths of steel reinforcing rod should be placed in the footing so they will project into the foundation wall and tie it securely to the footing. This usually requires careful spacing of these rods.

Sometimes the amount of concrete for the foundation can be greatly decreased by placing large stones in the trench and pouring the concrete around them to form the footing. If the stones are large it is a good idea to make the footings somewhat thicker than for regular concrete footings. Roughly, the thickness should be about 1½ times the size of the largest stones. For example, if 6" stones are used, the thickness should be 9".

*MASONRY FOOTINGS* - Bricks, concrete blocks, or rubble stone laid in mortar also make good footings. When using bricks, concrete blocks, or any *regularly* shaped materials, it is necessary that the bottom of the trench be leveled accurately; otherwise, the foundation wall may be unlevel. Either tamped sand can be used to level the bottom of the trench or a thin bed of concrete can be poured. For rubble stone footings, the trench does not have to be as level, but care must be taken to bring the height of the stones up so that the final surface - after being covered with a *thin* layer of mortar - will be level. Figure 31 shows a rubble stone footing.

Masonry footings may often be much cheaper to construct than concrete footings, since less cement is required. However, they are harder to lay and require more time to complete. Also, it is difficult to properly reinforce them. For this reason, they are not usually recommended for areas of hurricanes, high winds, and where the soil tends to swell.

Mortar used in the masonry or rubble footings should be of a high grade that will not fall apart with time. The following mix works well:

4 parts portland cement

1 part lime

12 parts clean sand

sufficient clean water to form workable mix

If masonry cement is available, use one part masonry cement, three parts sand and sufficient clean water to form a workable mix.

*FOUNDATION WALLS* - The foundation walls, which rest on the footings and support the walls of the house, must be strong, have a flat surface to start the earth wall on, be straight and they must be level.

Poured concrete, concrete blocks, burned brick, structural clay tile, or stones laid in mortar all make good foundation wall materials.

Again the most suitable, but probably the most expensive foundation wall is made from poured concrete. In earthquake or hurricane areas or where the soil swells considerably, it is advisable to reinforce the foundation walls in the same way as footings are reinforced. The amount, size and spacing of the steel reinforcing should be determined by a competent engineer or architect.

Well-stabilized earth, either in the form of blocks or rammed-in-place earth, may also be used. Since experience with these materials is limited, however, it is recommended that they be used only in areas of light rainfall and on sites that are well sloped to drain water away from the footings.

*SIZE OF FOUNDATION WALLS* - In constructing the foundation wall, two things must be considered - the thickness of the wall, and the height of the wall above the ground level.

Foundation walls should be made at least as thick as the earth walls that they support. Sometimes they are thicker, but this is true only when they will be used to support other loads, such as the interior floors.

The height of the foundation wall should be sufficient so that rain splash will not reach the earth blocks and cause them to erode or wash out. This height depends on the amount of rainfall and width of roof overhang. For dry areas (rainfall less than 15 inches per year) and wide roof overhangs, the foundation walls should extend 8 inches above the ground surface. For high rainfall areas and small roof overhang, 18 inches above the ground is required and under normal rainfall conditions, 12 inches is required. Even when a stucco or surface finish is used over the earth walls, the foundation wall should extend to the heights given above.

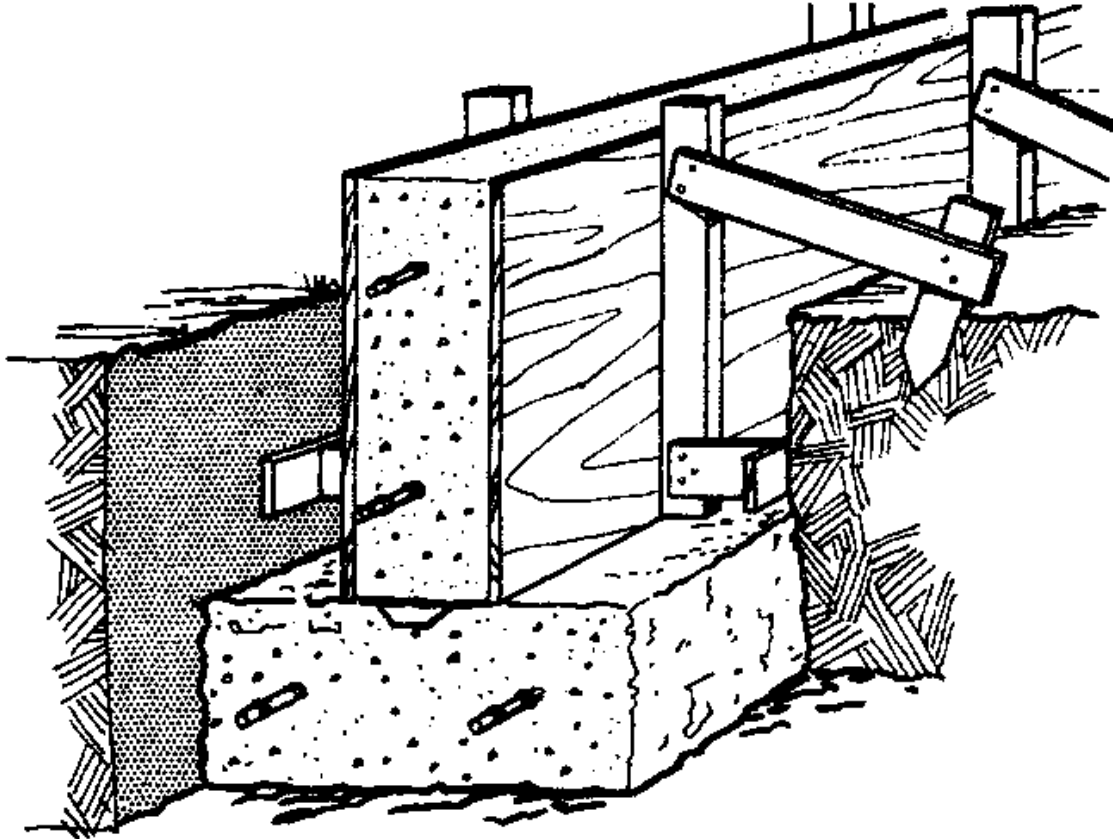

Figure 29.

**CONCRETE FOUNDATION WALLS** - When using poured concrete for the foundation walls, use forms (shuttering) to hold the concrete until it hardens. These forms are set directly on top of the footing and must be solidly braced against the walls of the trench or at the ground surface to prevent movement when the concrete is poured. They should also be thick enough and braced well enough to prevent bulging.

Wood sheathing  $1\frac{1}{2}$  to 2 inches thick and braced about every 6 feet works well, or 1" tongue-and-groove boards braced every  $2\frac{1}{2}$  feet. If plywood is used, a thickness of  $\frac{5}{8}$ " to  $\frac{3}{4}$ " is satisfactory. A typical wood form is shown in Figure 29. Constructing wood forms is a misleading job. They always seem too strong, and therefore wasteful, while they are being built. Once the concrete is poured, it is too late to correct the mistake of not making them strong enough. A bulging form is difficult or impossible to repair. *Do not try to save money by making the forms too weak.*



The concrete forms should be carefully placed in the correct position and then well braced to prevent movement as shown in Figure 29. Once the forms have been braced, the top of the foundation wall should be located by driving nails and drawing lines on the inside of the forms. This can be done accurately using the water hose method given in Chapter 3. This height should be marked on the forms all the way around the house as shown in Figure 30.

If reinforcing steel is to be placed in the foundation wall, it is easier to set only one side of the forms first (usually the inside form), mark the correct height of the wall on the form and then place and tie all of the reinforcing steel before erecting the remaining forms. This helps to line up the steel and get it to the correct height.

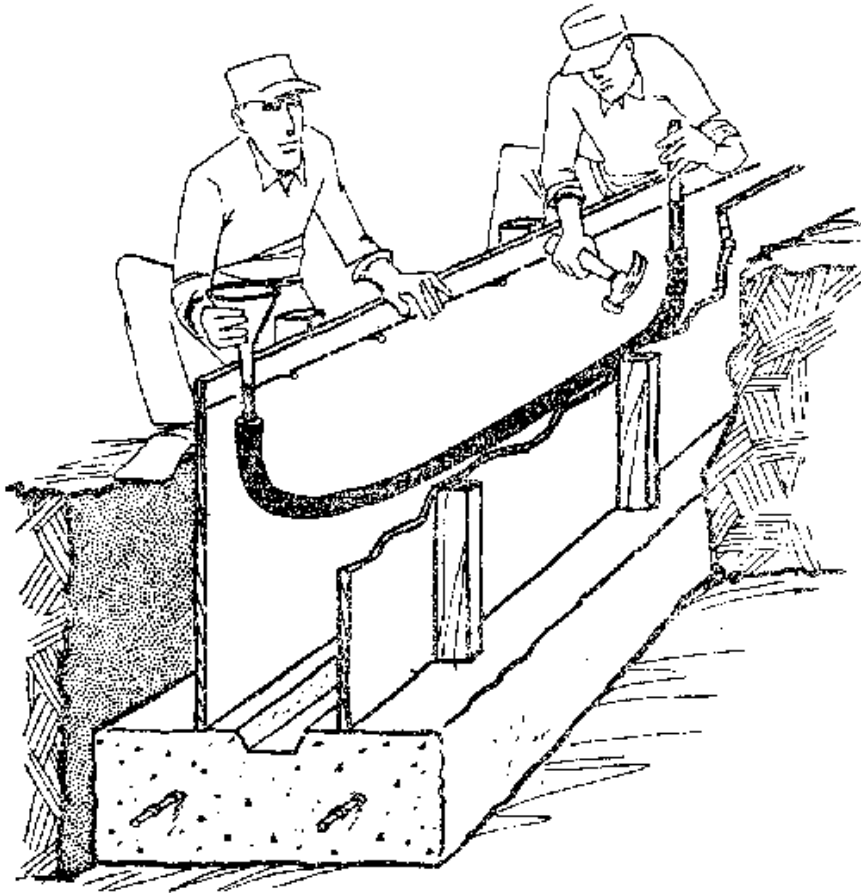

Figure 30.

After the forms have been placed and checked for correct alignment and strength, the footing inside of the form should be swept clean, then lightly sprinkled. It is a good plan to leave a few small openings in the bottom of the forms so trash can be swept out. Be sure to close these openings before the concrete is poured. To keep the concrete from sticking to the forms, they should be wetted with water just before the concrete is poured, or better still, mopped with light oil before the forms are erected, not after.

*Once the concrete pouring begins, it must be continued until the entire foundation wall is completed. Otherwise, undesirable joints in the concrete will be formed. The concrete should be "rodded" or tamped into the forms with a smooth steel or wood rod to pack it down solidly. Otherwise, you might get air pockets which weaken the wall seriously. Proper rodding is important over the entire foundation wall, but it is especially important on the outside face because not enough rodding can result in holes that look bad. The concrete can be the same as that used for the footing with perhaps a little more water to make it easier to work. Placing ease may be estimated by the*

method outlined earlier under "concrete footings." If you use the method outlined earlier under "concrete footings," the rock should dent the mix about 2-2½ inches.

The gravel in the concrete should not be too large or it will get wedged between the form and the reinforcing steel. The largest size stone in the concrete should be about ½ of the distance from reinforcing bars to the edge of the form or between adjacent reinforcing bars, whichever is smaller. Remove the forms two days after the wall is poured. Keep the concrete moist by sprinkling or covering with wet sacks for a few more days. If there are any voids in the concrete, patch them as soon as the forms are removed. Use a grout or mortar mixture and smooth it out with a trowel or straight stick.

*MASONRY FOUNDATION WALLS* - Requirements for masonry foundation walls are the same as for poured concrete walls; that is, the walls should be straight, level and strong.

For laying the walls, a good, strong mortar should be used. The following mix has been found to be good:

4 parts cement

1 part lime

12 parts clean sand

sufficient water to make a workable mix.

The way to lay the blocks or bricks is the same as described in Chapter 10 (page 100) for laying earth blocks. Use the string lines on the batter boards to guide you in obtaining straight walls. The water hose method should be used to make sure that each course of blocks or bricks in the wall remains level during construction. If it is absolutely necessary to use masonry foundation walls in earthquake or hurricane areas, they can be reinforced by using mesh especially made for this purpose, heavy woven fence wire, or even small (3/8" or less) reinforcing bars. The reinforcing is placed between horizontal joints and sufficiently protected with mortar to prevent rusting. Again, a competent architect or engineer should design the correct amount, type, and placement of the reinforcing. Also, if hollow tile or blocks are used, it is a good idea to fill many (sometimes all) of the holes with mortar to obtain extra strength.

*RUBBLE FOUNDATIONS* - Often, a large supply of stones, broken brick, or other suitable materials is available for building a rubble foundation. This type of foundation works well and is economical, although it is harder to reinforce. Instead of building a footing and foundation wall, the rubble foundation can be constructed as one solid piece which tapers up so that it is the width of the earth wall at the top. (See Figure 31.) The width at the bottom is determined in the same way as for footings using Table 4.

Only hard, durable materials should be used in a rubble foundation. Mortar of the same type described for masonry foundation walls is suitable for holding the rocks together. Often, during the clearing of the site and digging for the foundation, suitable rocks and other materials can be saved for construction of the rubble foundation.

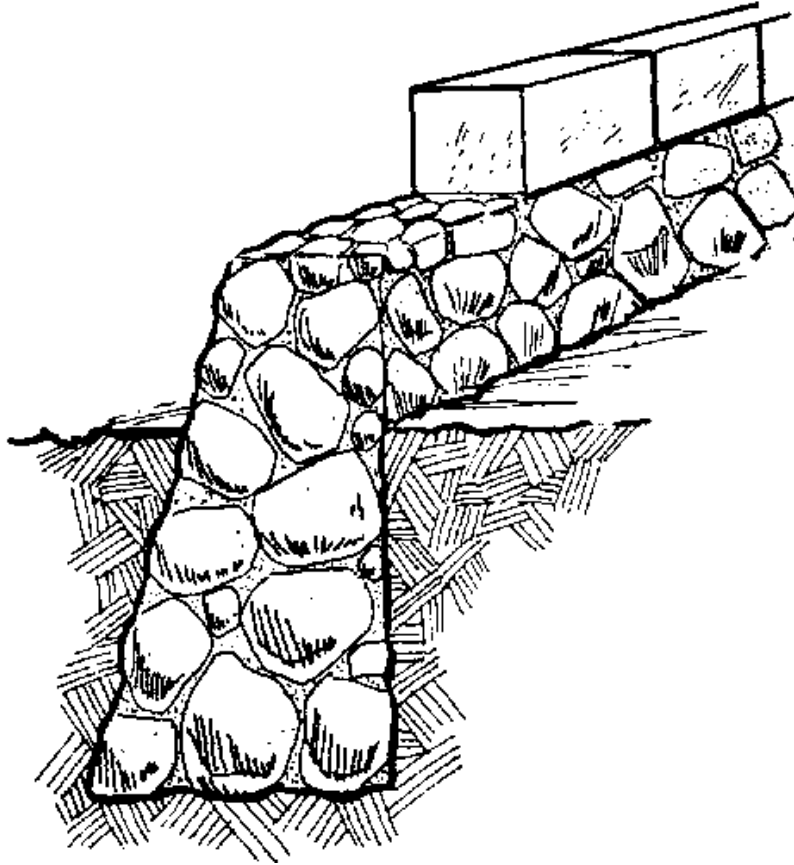

Figure 31.

Construction requires patience and it is more difficult to obtain the correct level and straightness using rubble. The largest stones available should be placed at the bottom of the foundation and the top should be covered with a thin layer of mortar to provide a smooth, level surface for the first layer of the wall.

*BACKFILLING THE FOOTING EXCAVATION* - Since the excavation for the foundation wall and footing is wider than the foundation wall, it must be backfilled. Preferably, the backfill material should be the native earth removed from the excavation. It should be placed back into the excavation as close as possible to the same moisture content and compactness of the surrounding, undisturbed soil. This always means tamping the soil back in place. Tamp it in thin, equal layers on both sides of the foundation wall so that there is no possibility of damaging or forcing the wall to lean. You can use the same kind of tamper described elsewhere for rammed earth.

## **Chapter 6: Lightweight roofs**

Unless the roof of the house is to be made of heavy material, such as earth, you can build the roof right after the foundation has been completed.

If the roof is built before the walls, it needs to be supported by temporary or permanent studding of heavy upright timbers or, if available, any one of several kinds of metal uprights.

There are several practical lightweight roofing materials. Among them are corrugated asbestos sheeting, corrugated metal sheets, lightweight tile or thatch. If any of these are to be used, there are a number of advantages

to building the roof right after the foundation has been completed.

Here is why a roof in place can be of great advantage to the builder before the walls are built:

1. The shelter makes a good curing space for building blocks or bricks.
2. It provides desirable shade for curing earth walls.
3. It makes a good work area and provides shade for the builders, especially in warmer climates.
4. Tools and materials can be kept under the roof to protect them from weather damage.
5. It can even provide temporary living space.

This method has the following disadvantages:

1. It is harder to do than building the roof after the walls are completed.
2. Extra material is needed for the roof supports.

In many cases, these supports can be left permanently in place. If they are not left standing after the walls are finished, of course, these timbers can be used again for something else.

Figure 32 shows the roof of a Korean house in place before the walls were constructed.

Full details on how to build roofs are covered in Chapter 12.

## **Chapter 7: Preparing the soil**

Once you have your source of soil and have experimented with it enough so that you know how to use it best, the next step is to *work out a careful and orderly plan, step by step*, of what you are going to do with it.

To build a house of earth blocks or rammed earth means that you will have to:

1. Move several tons of soil.
2. Have a source of water handy.
3. Prepare your soil mix (adding stabilizers if necessary).
4. Set up a block-making or ramming operation.

To do these things efficiently, you must have what you need where you need it. For example, if you plan to build a house of blocks, they should be completed and stacked for curing as close as possible to where they will be used in the walls of the house.

If the roof has been built beforehand, as suggested in Chapter 6, the block making operation should be set up under it. The roof will provide shade in sunny weather and will permit work to go on if the weather is bad.

In planning the location of each step, study the order shown in Figure 33.

*DIGGING THE SOIL* - It does not matter how the soil is dug and moved to the place where it will be used. There are, however, some points to remember whether the soil is dug by machinery or by men with picks and shovels

Machine dug soil usually is lumpy. It is important that all clods or lumps are completely broken up before mixing in the water and stabilizer.

If the soil is lumpy, you should provide a space to break it up so that it will not be mixed with the freshly dug earth. If the soil is dug with picks and shovels in the first place, you will find that very little breaking up will be needed.

Often, you will be mixing two or more soils together to make your best possible mix. If you do, bring your soils to your building site and keep the different kinds into different piles. When you blend them later, you can make the mixture you found to be the best from your earlier testing.

Often, the builder will find a situation like this: a layer of top soil about a foot or more thick; then a couple of feet of sand under that, and beneath the sand, a layer of clay or sandy clay. If the builder will first get rid of the top soil, he can make his building mixture as he goes along by digging down the sides of the hole through the layers. If he is able to do this, then, he does not have to spend a lot of time later on making his proper blend. He can do all this as he digs by paying attention to the amounts of the different kinds of soil he digs. Do it this way if you can, of course, instead of removing the soil by digging out each layer and stockpiling it separately.

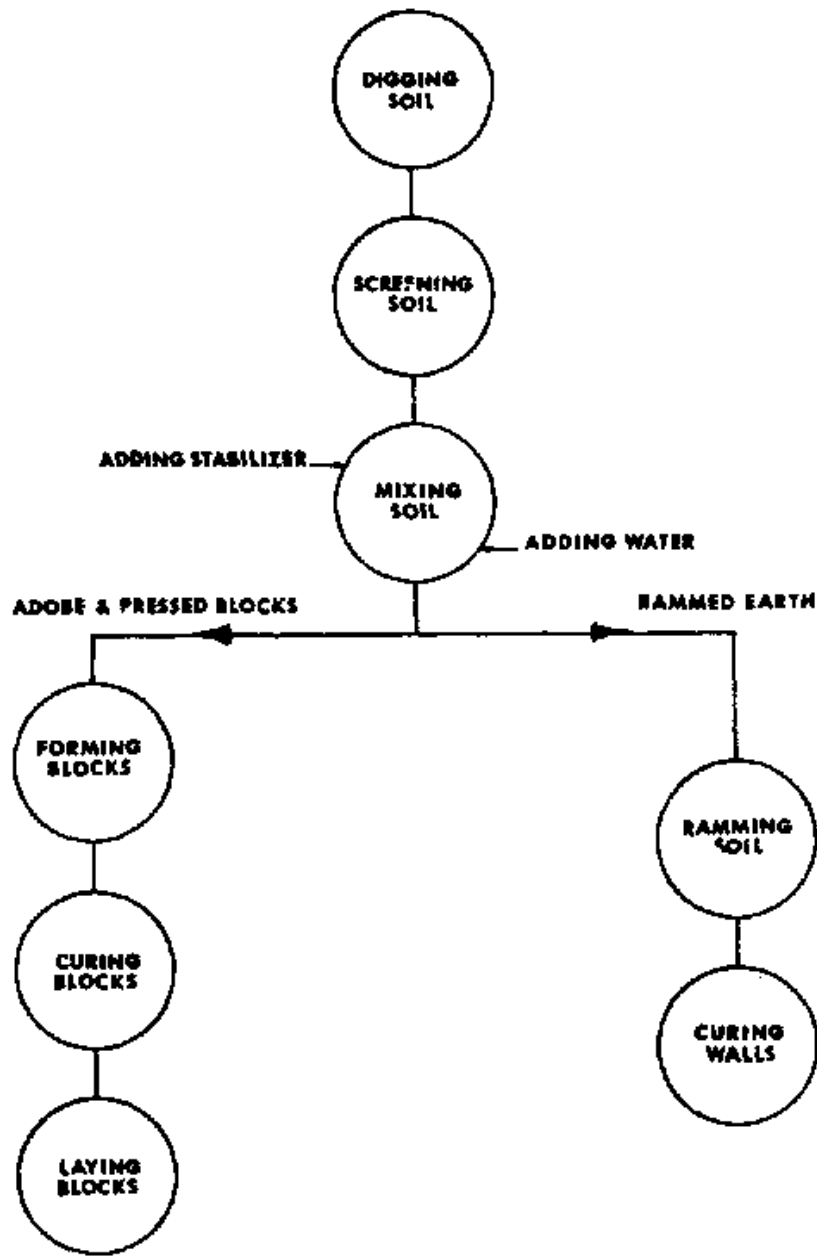

Figure 33.

*MOISTURE CONTENT* - The moisture content of the soil as you dig might be very close to the right amount needed for best compaction. (See pg. 30 to determine whether you have the right amount of water.) If it is, you can put your mix directly into the block-making machine or in the forms for rammed earth, unless, of course, you are going to mix stabilizers in the soil.

If the soil type is just right, as it sometimes is, but the mixture is too dry, the pit can be sprinkled with water before the earth is dug out. A little experience will quickly tell the builder just how moist the soil should be and how deep the water will penetrate into the sides of the pit.

For adobe construction, it is better to add water while the digging is going on. In this case, the mixing is also done in the pit. But if dry or powdered stabilizers are being added, they must be added to fairly dry soil first because it

is difficult to mix them evenly into wet or muddy soil.

*PREPARING THE MIX* - If your soil mix is made up of two or more separate soils, here are some rules to follow in order to get best results:

1. Get rid of undesirable material. Be sure to remove all roots, leaves, trash and any other organic material.
2. Break the soil down to proper size before blending.
3. Stones larger than 1½" should be gotten out.
4. After all dirt clods have been broken up and crushed, put the soil through a screen with openings between ¼ and ½ inch. See Figure 34 for screens that have worked out well. Anything that does not go through should be discarded or crushed more.

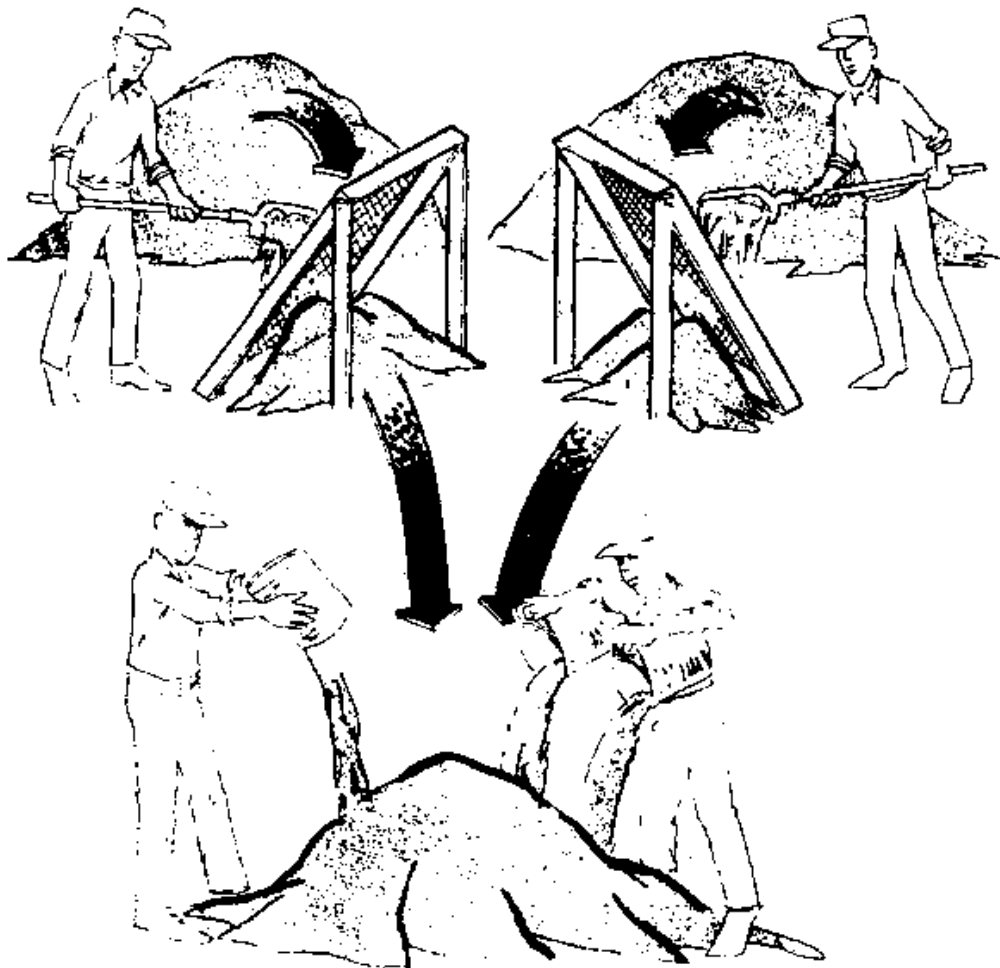

Figure 35.

Of course, if rocks up to 1½" are being used in rammed earth or blocks, then, the size of the screen openings should be big enough to allow the size you want to use to go through. In this case, extra care must be taken to see to it that clods of dirt are completely broken up. If large clods are in the mix, water may not penetrate them. Later, when the wall becomes soaked by rain, the clods may swell and ruin the wall, or they could wash out and leave a hole that weakens the whole structure.

When two or more soils are to be blended, for example, when they come from different pits, it is best to sieve them separately and keep them in separate piles. Then, when it is time to mix them together, the correct blend can be measured out, such as "one pail of this soil to two pails of that soil," etc. This operation is shown in Figure 3a. Weighing the separate soils does a more accurate job, but it also takes much longer. A little practice will teach the builder to make his blends accurately enough so that weighing is not necessary.

During the blending operation, be sure the right mixture is kept the same. If it is a 2-1 mix, be sure it is always two to one.

*MIXING THE SOIL* - This is one of the most important steps in the whole operation. Mixing with the right amount of water is absolutely essential. The quality of a finished wall depends on good mixing and the right moisture content at the time the soil is being pressed into blocks or into a wall.

There are three methods for mixing the soil you can use:

1. A motor-powered mixer.
2. A manual or animal-powered mixer.
3. Or a mixing board and shovels.

If available, a motor-powered mixer can save you a lot of time on a large project but you must have the right kind of mixer. Mixers which have paddles attached to the drum so that drum and paddles rotate as one piece (such as in an ordinary concrete mixer) will not be satisfactory for mixing soil for pressed blocks or rammed earth unless the soil is very sandy. The best type to use is one that has paddles or teeth that rotate in a stationary drum or container. If you are making adobe, a concrete mixer will work fine because an adobe mix is much wetter.

Several commercial mixers are available but a homemade mechanically powered mixer can be built if some type of motor is available. For small mixers, a gasoline engine of approximately 5 horsepower works well. Tractors or automobiles may be modified so that a belt or chain drive take-off can be used.



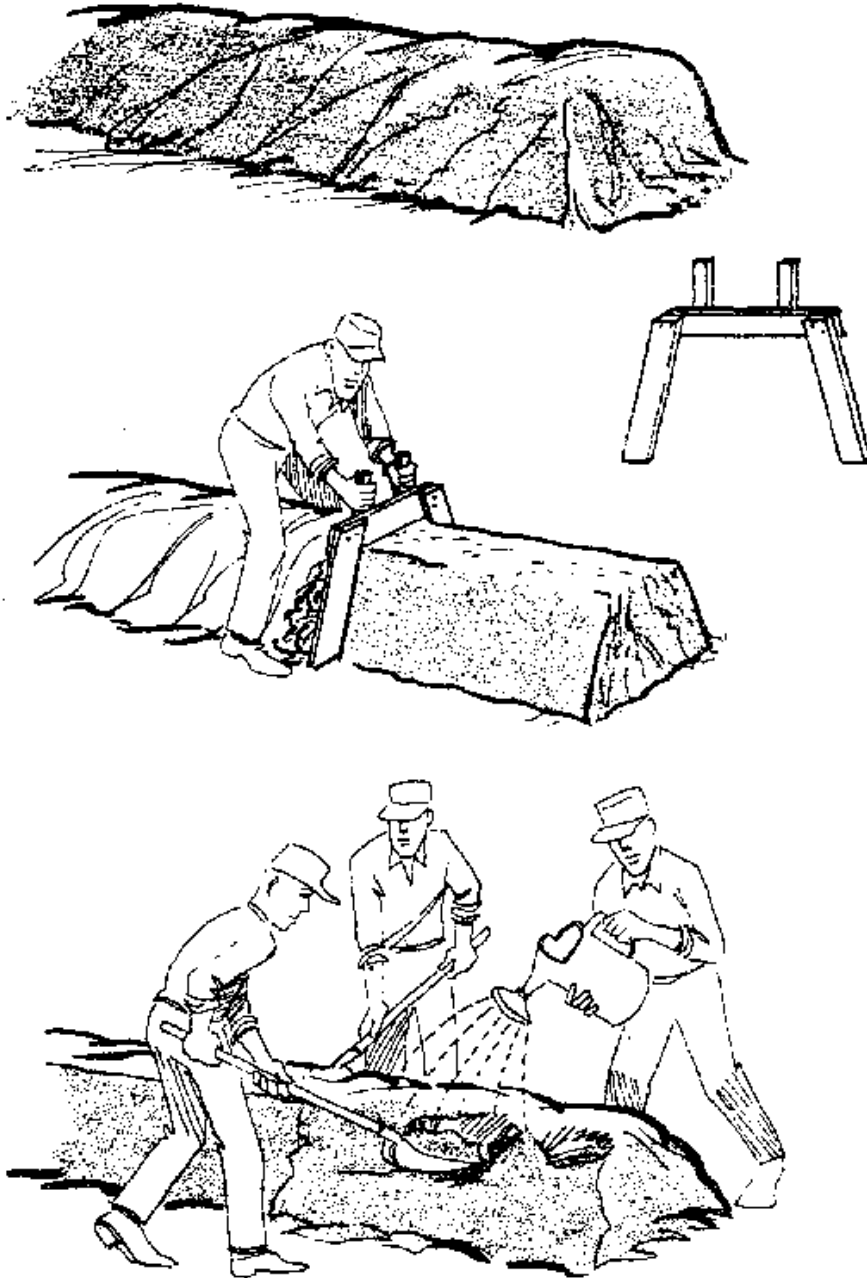

Figure 37.

A 55-gallon oil drum makes a good container for mixing. Figure 36 shows a successful mixer that you can make yourself.

A 25 or 30-gallon oil drum can be wed to make a smaller hand or animal powered mixer.

Be sure you have mixer large enough for the job.

For a single house project, the cheapest and easiest method for mixing soils is by hand. All you need is a flat surface and a shovel or a hoe. The floor of the house, if concrete, makes an excellent surface if you have built it beforehand.

To make sure that all batches of mix are the same, soil, water and stabilizer (if you are using them) must be measured accurately. The best way to do this is to lay out a long row of soil, about 18 inches wide. Then use a template as shown in Figure 37 to level off the row to the right height, maybe six inches or a foot. Fill in the low spots and level again with the board. For every batch of mix, be sure that the rows are the same length and all are of the same width and thickness. If you are using stabilizers, sprinkle the right amount on top of the row. Pour a little water at a time and use the shovel to turn the material over and work it toward the center of the row. An ordinary garden sprinkling can is ideal for adding the water. But be sure to add the same amount of water and stabilizer (when used) to each batch. If you make each row the same way every time and use the same amount of water for each row, each batch of mix will be the same.

*Do not mix more soil than you can use at one time.* There is one exception, however. In cases where you are using lime with soil containing a lot of clay, thoroughly mix about half of the lime required and then add the water and allow it to "season" for a day or two. While it is seasoning, cover the mix with wet sacks or leaves so the soil will not dry out. During this seasoning time, the lime will react with the soil to break down any clods or lumps that clay has. After the mix has seasoned, work it again carefully with shovels, add the rest of the lime, mix and add a little more water, if needed. Then, it is ready to be made into blocks or rammed into a wall.

## **Chapter 8: Making adobe blocks**

The art of making adobe earth blocks is ancient - and the old hand-mixed methods work as well today as they ever did. But, if you have some machinery to help mix the soil and move it, you can make good blocks a lot faster.

*MANUAL (OR OLD) METHOD OF MAKING ADOBE BLOCKS* - When a lot of cheap labor is available, use it. All you need are forms for molding the blocks and simple tools for mixing and moving the earth.

The forms may be made for single blocks, but two- or four-block forms are better. Strong, long-lasting forms can be made from 2-inch thick planks. When the forms do not have to last a long time, 1-inch thick planks or ¾-inch thick plywood can be used. The forms will receive a lot of wear, so make strong ones. Use plenty of nails or bolts or, better yet, reinforce them with strips of metal at the corners. Since they will be wet much of the time, it helps to soak the forms in oil for a while before you start to use them. Some people line the insides with metal so the forms will last longer and the blocks can come out easier.

Adobe blocks can be made almost any size, but they should be kept small enough so that one man can lift them all day long without tiring too much. An average workman can do this if the blocks weigh about 50 pounds or less.

Adobe blocks are commonly made 4 to 6 inches thick. The width of the block matches the desired thickness of the wall, between 9 and 18 inches. The length, then, is controlled by the weight of the block. Two typical sizes of blocks that have been used are 5x10x20 inches (weight about 55 pounds) and 4x12x18 inches (weight about 50 pounds).

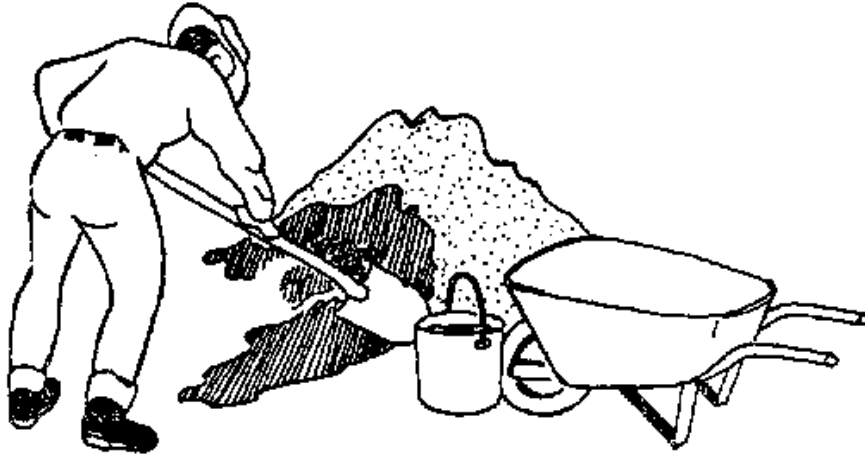

Figure 38. Preparing the soil mix.

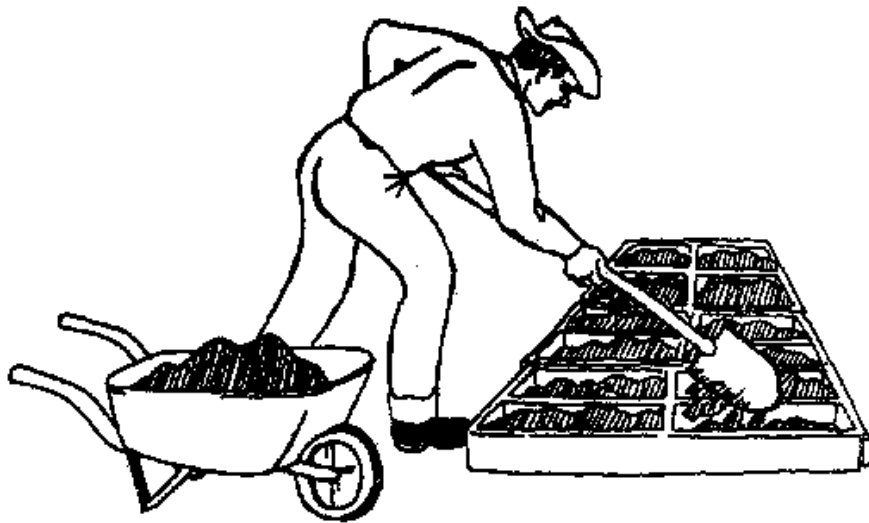

Figure 39. Charging the forms

The manual method is most efficient when four workers are used. Two men prepare and mix the soil while the other two mold and remove the blocks, then, clean the forms. The dry soil is prepared as explained in Chapter 7. Then it is mixed with water as shown in Figure 38 until the soil barely flows when lightly kneaded. A good way to estimate whether enough water has been added is to use a stick to make a 3-inch deep, V-shaped groove in the soil mix. The mix is wet enough if the sides of the groove bulge and just begin to flow together.

Bituminous emulsions or other liquid stabilizers are added to the soil mix at the same time as the water. Dry or powdered stabilizers are mixed in before the water is added.

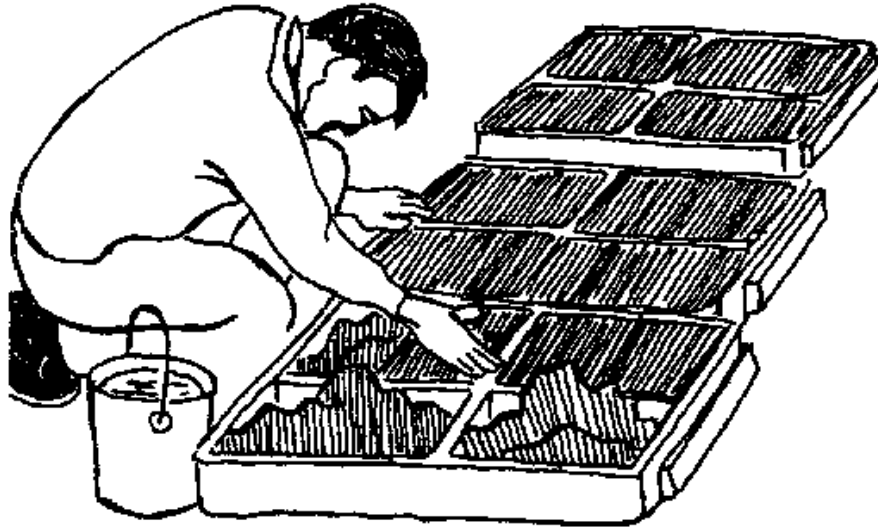

Figure 40. Kneading and leveling the blocks

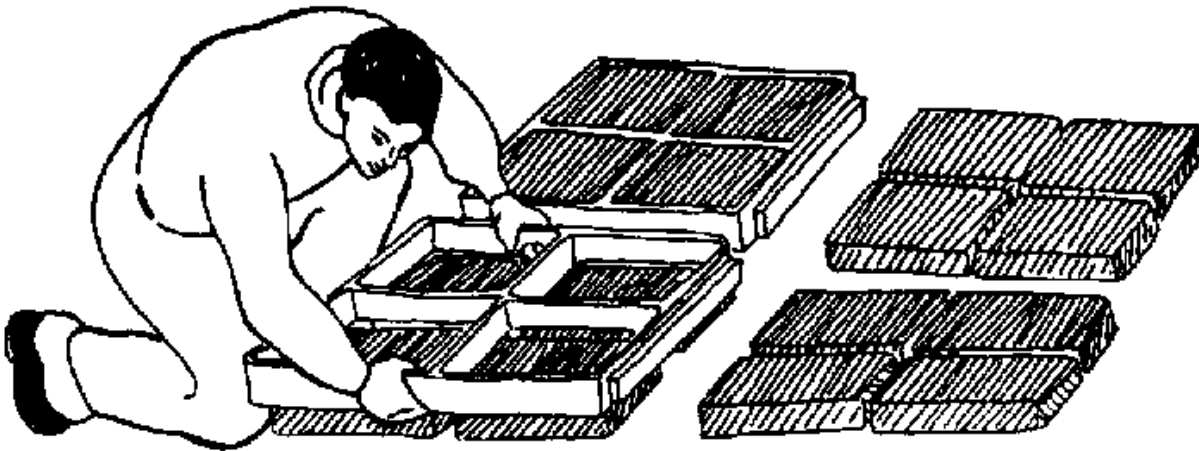

Figure 41. Lifting the forms from freshly made blocks.

After thorough mixing, the adobe mix is placed in the forms as shown in Figure 39. It helps to drop or throw the mix in the forms so it packs tightly. The mix is then kneaded by hand as shown in Figure 40 to fill all of the corners and remove all air bubbles. If the kneading job is done well, the adobe blocks will be solid and have strong corners and edges. After kneading, a small board or trowel is used to cut off the extra soil and smooth the top edge of the molded block. A little water sprinkled on top of the block will help in smoothing it off.

As soon as possible the forms are lifted from the freshly made blocks as shown in Figure 41. The only way of knowing when to remove the forms is to try it. If the blocks slump or bulge too much, either the forms are being removed too soon or the mix is too wet. If the mix sticks to the forms when they are removed, it is too dry or the forms have not been oiled enough. With some soils the forms may be removed immediately. With other soils you may have to wait longer.

After removing the forms they are washed as shown in Figure 42 and returned to the casting bed for the next batch.

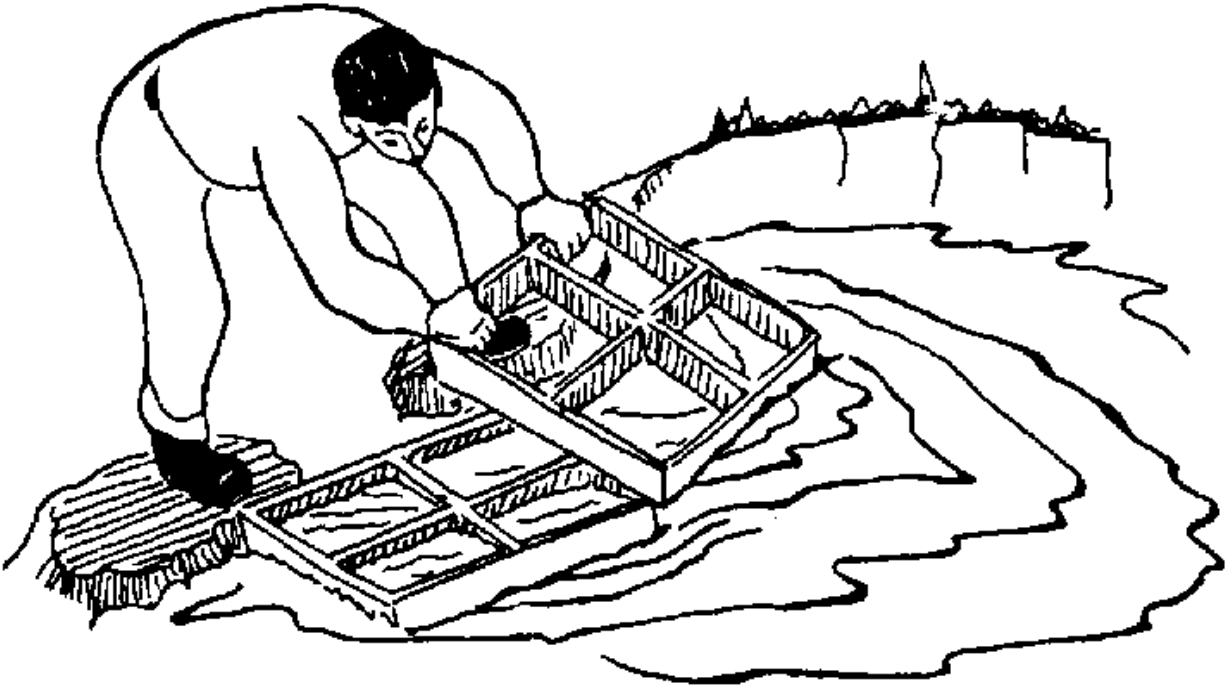

Figure 42. Washing forms for next cycle.

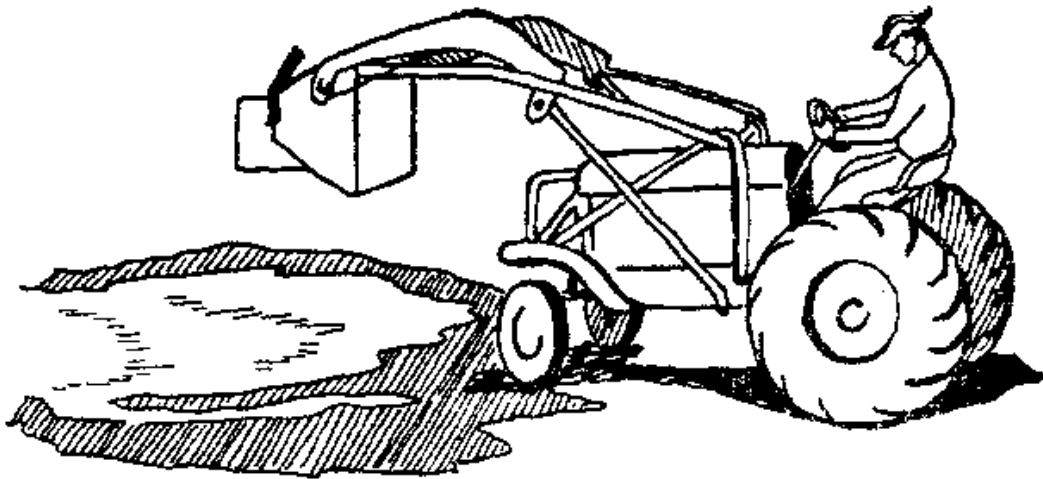

Figure 43. Front end loader is used to mix soil with water in large sump.

*MECHANICAL METHOD OF MAKING ADOBE BLOCKS* The mechanical method of making adobe blocks is not much different from the hand method. By using machinery to mix and dump the soil you can make blocks faster, but you need bigger forms and more of them. A larger casting bed is also required.

The size of the adobe blocks is the same as those made by the manual method, but the forms should be big enough to make 12 to 36 blocks at once. For these bigger forms, use 2-inch thick lumber. If enough water and earth are available to keep the mixing process continuous, as many as 40 to 50 forms may be used.

Using the mechanical method, two or three workers may be enough. One man operates a tractor with a front-end loader such as shown in Figure 43. He digs the soil if necessary, mixes the soil and water in a large pit and then scoops the soil mix up and drops it in the forms. This operation is shown in Figure 44. The other men knead the

mix into the forms and lift the large forms from the molded blocks at the proper time. This method will vary depending on the type of mechanical equipment that is available. The front-end loader was used only as an example.

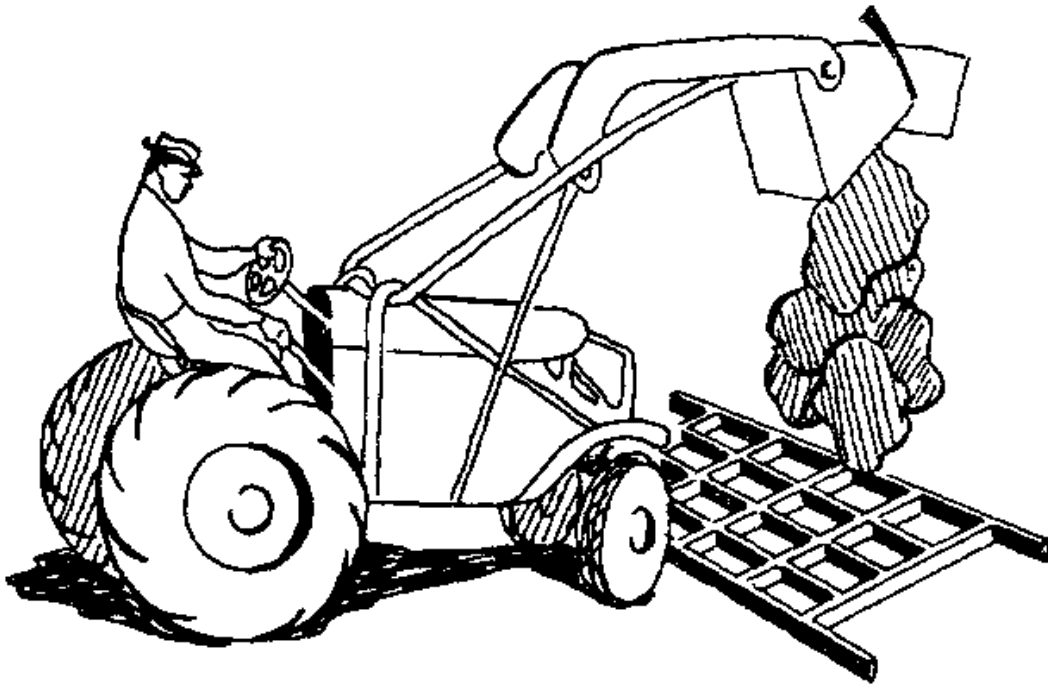

Figure 44. Machine transports prepared soil mix to multi-forms.

*CURING ADOBE BLOCKS* - Adobe blocks must be cured or sun-dried before they can be used. The usual way of curing the blocks is as follows:

1. After the mold is removed from the newly made blocks, leave them in place two to four days without being disturbed. Gang molds may be used with a pallet to speed this operation. The mold can be removed after the soil mass has set sufficiently to hold its shape and the pallet with blocks can be set aside out of the way while curing takes place.
2. As soon as the blocks are strong enough to be picked up without chipping or breaking, place them on edge to finish curing. At this time any loose sand or other material clinging to the block is scraped off with a small stick (see Figure 45). Curing will take about a month, but it depends a lot on the weather and the type of stabilizer in the block.
3. If **stabilizers** such as lime or cement are used, cover the blocks with wet cloth or straw as soon as the molds are removed. Keep them moist for seven days and then turn them on edge to complete the curing. (See Figure 58, Chapter 9.)
4. At the end of the curing period, the blocks are stacked on edge as shown in Figure 46 so they will take up less room.

Because of the long curing period for adobe blocks, a large curing area must be available. During dry, hot seasons they can cure without a protective roof. But if it is apt to rain during the curing period, a protective covering will be needed. The blocks shown in Figure 47 were ruined by rain before they had a chance to cure.

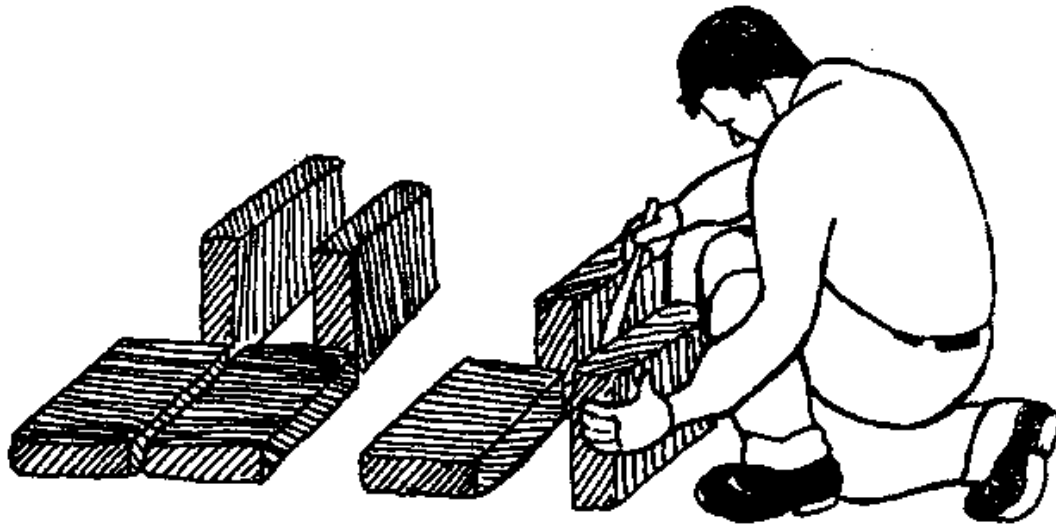

Figure 45. Unstabilized block is turned on edge to dry after two to four days.

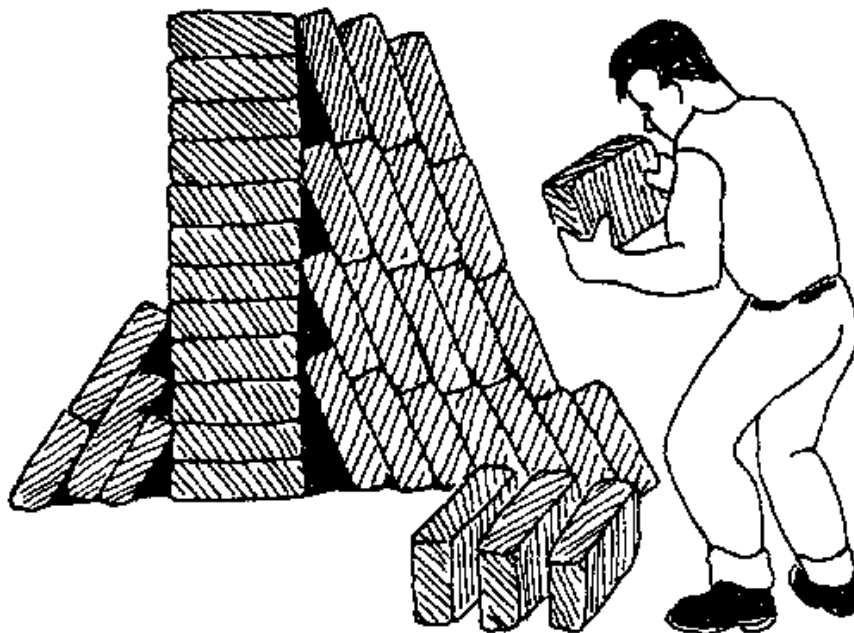

Figure 46. Adobe block is stacked after a month of curing.

An example of an inexpensive shed used for curing blocks is shown in Figure 57 in Chapter 9. But all types of covering must allow the air to circulate around the blocks or they will take too long to cure.

Some builders have laid adobe blocks before they have cured completely. This can be done if the blocks do not shrink after being laid and if they are strong enough to be handled without breaking. The savings in time may not justify this procedure, however. It is really better not to lay uncured blocks.

*CHECKING QUALITY OF BLOCKS* - Controlling the quality of adobe blocks during construction is not as difficult as it is for pressed earth blocks because moisture content is not so important. It still should be done, though. You can make quick tests such as the reaction to shaking, dry strength, etc., explained in Chapter 2 to determine whether your soil mixture has changed. You should also make tests on the cured blocks to determine whether the correct soil is being used and whether the correct amount of stabilizer is being added. The following

tests are recommended.

1. Strength tests of the cured blocks should be made often using the procedures given in Chapter 2. From the first 100 blocks made, two or three blocks should be selected for strength tests. Later it is sufficient to check one block out of every 150 to 200 blocks.

2. *Spray testing* is an easy way of checking the quality of adobe blocks and assuring uniformity. These tests should be performed on cured blocks using the procedure described in Chapter 2. The number of tests to be performed is the same as for the strength tests.

3. *Absorption test* as described in Chapter 2 is one of the easiest ways of checking uniformity of the blocks. Check the same number of blocks as for the strength test.

All of the control tests should be done on blocks which have cured for the same amount of time. If tests are performed on blocks which have cured for one week and then other tests are performed on blocks that have cured three weeks, you could not expect the results of the tests to be the same.

## Chapter 9: Making pressed earth blocks

### METHOD OF CONSTRUCTION WITH BLOCKS OF STABILIZED SOIL

FOR EITHER INTERMEDIATE WALLS OR FOR COLUMNS  
IN A WALL WITHOUT INTERMEDIATE WALLS.

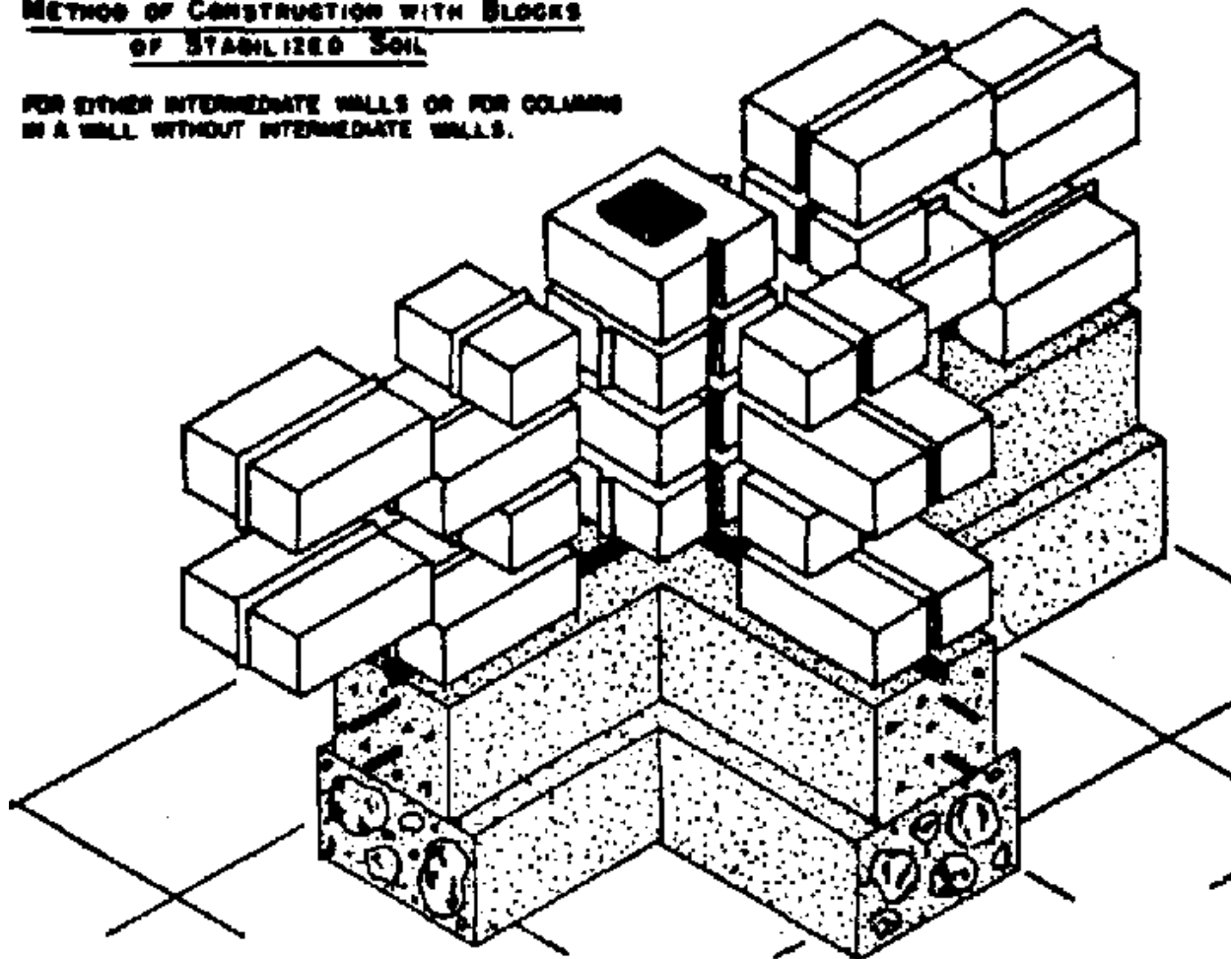

Figure 49. The various shapes of blocks produced by the Land-crete block making machine allow rigid construction of corners and tees.



*ELLSON BLOCKMASTER* - The Wilson Blockmaster is a manually-operated block (or brick) making machine manufactured by Wilson Equipments (Pty.) Ltd., 285 Fox Street, Johannesburg, South Africa. The machine operates on a lever system with a constant length of stroke so that the block thickness is always the same. The high lever ratio (500-1) makes a very dense, solid block. Different molds can produce blocks 9x12x4 inches or 6x12x4 inches. Other molds and attachments are available to form interlocking blocks, 4½x9x4 inch bricks or 18x9x4 inch hollow blocks. The manufacturer claims a production rate of 900 to 1100 blocks per 8 hour day with an increased rate up to 1400 to 1500 blocks per day with a semi-automatic loader attached. If the 4½x9x4 inch bricks are made, the rate is approximately doubled since two bricks are made in one operation. Two men would be required to operate the machine and two or three more to prepare the soil.

*CINVA-RAM* - The CINVA-Ram (Figure 52) was developed by the Inter-American Housing and Planning Center (CINVA) at Bogota, Colombia, in 1952. It is operated by manually applying pressure on a long lever arm. It produces blocks which are 11½x5½x3½ inches (either hollow or solid) and will also produce 11½x5½x1½ inch tiles for roofs or floors. The long lever arm arrangement produces dense, high-quality blocks. The CINVA-Ram is presently distributed by Metalibec Ltda, Apartado Aero 233-NAL 157, Bucaramanga, Columbia, South America, under license from I B. EC. Housing Company, New York, U.S.A. The machine weighs only 140 pounds and is the lightest of the four machines mentioned here. Three men, doing all of the work, including processing, mixing, molding, etc., should make 300 blocks a day. Five workers can make 600 per day by dividing the jobs.

*SUMMARY OF BLOCK-MAKING MACHINES* - All of the machines discussed above make high quality earth blocks. Each machine certainly has its advantages and disadvantages and certain machines will be available in some areas of the world where others will not. There are probably other good machines that will make good earth blocks, but it is not practical in this manual to discuss all of them. We will use the CINVA-Ram machine to discuss the procedure for making blocks.

*BLOCK-MAKING OPERATIONS* - A team of five or six men working with one machine achieves the best production. Three men handle the digging and processing, while two men operate the machine and mold the blocks. Another man may be used to stack the blocks for curing.

*PLACING SOIL MIX IN MACHINE* - With most of the block-making machines (particularly with CINVA-Ram) it is necessary to get the correct amount of soil mix in the machine each time. Fast, simple weighing equipment can be used, but a wood or metal scoop will do almost as well. A scoop for the CINVA-Ram is shown in Figure 53. A worker can scoop into a loose pile of prepared soil mix, scrape off the excess material with a piece of straight wood or sheet metal, and then dump this measured amount directly into the machine. The size of the scoop is determined by the correct amount of mix to make a dense block. Another way is to use only one size scoop but use an adjustable scraper as shown in Figure 53.

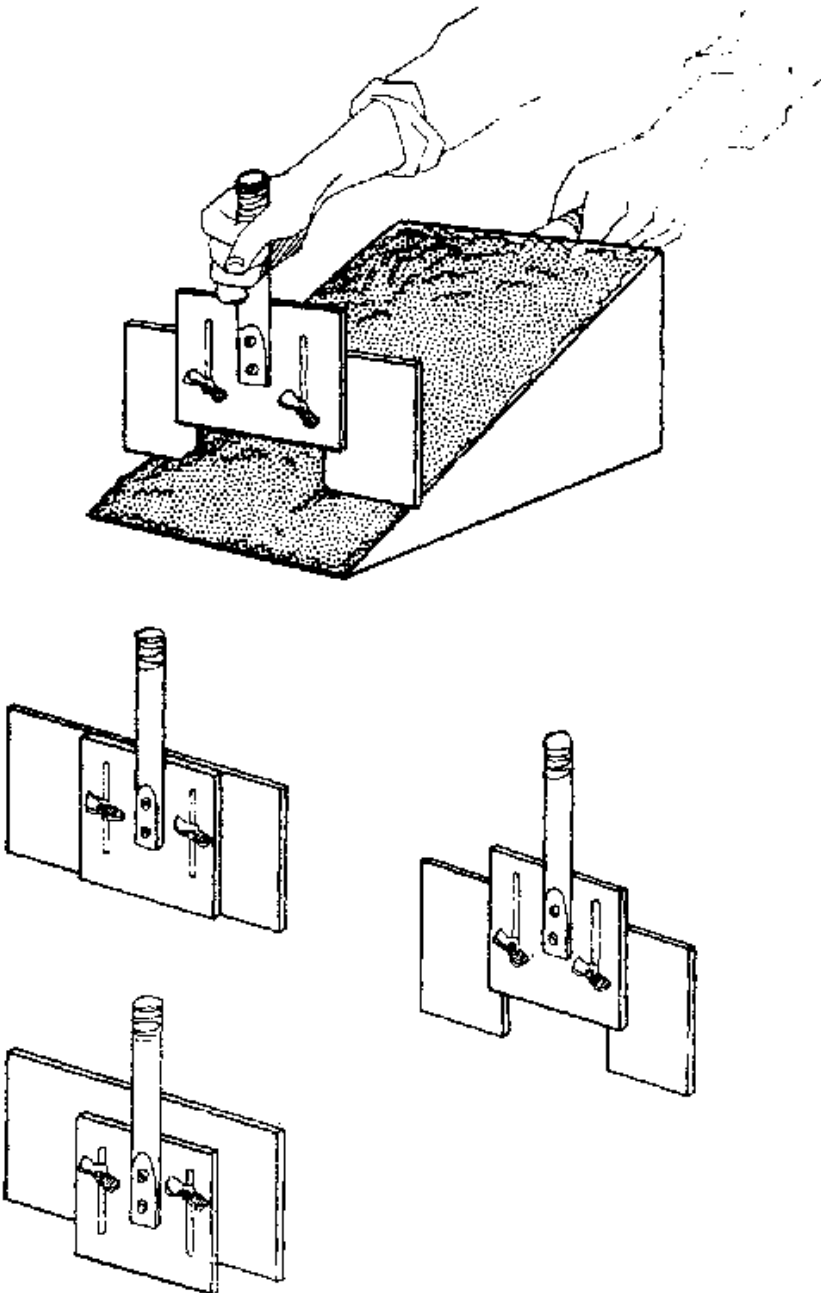

Figure 53.

Before each scoop of mix is placed in the CINVA-Ram, a light coat of oil should be brushed on the sides and bottom of the molding box. A mixture of 1 part engine oil and one part of kerosene is fine. The oil coating keeps the blocks from sticking to the sides of the mold and makes them easier to force out.

The scoop of soil mix is then placed in the oiled mold box. For many soils, a scoopful of loose material will not completely fill the mold box and the cover can be easily closed. Some soils, however, have a tendency to "fluff" when moist (usually the sandy materials do this) and they must be lightly pressed down by hand before the mold cover can be closed. It has also been found that many blocks are not compressed tightly at the corners and these corners will later chip or break off during handling. This does not affect the overall strength of the block but can spoil the looks of the wall later on. To avoid this problem, loose mix in the corners can be pressed down tightly

by hand or a little excess soil mix can be placed in each of the corners.

*PRESSING THE BLOCKS* - The worker who fills the mold box slides the cover on. His partner applies the pressure on the lever. This is a most important part of the operation and requires practice to do well. The CINVA-Ram was developed so that as little as 70 pounds of force applied to the end of the lever produces a block dense enough to be satisfactory. However, it has been proved that denser blocks are much stronger and more weather-resistant. So, it is recommended that at least 130 pounds of force be applied to the lever arm; that is, a man weighing about 130 pounds should be able to apply all his weight to bring the lever down to a level position.

A good block depends on the correct amount of soil in the mold box. If the lever arm can be pushed to the level position without pressing hard, then not enough soil has been placed in the mold and the block will not be dense. If too much soil has been placed in the mold, then the lever arm cannot be brought down to the level position, even with considerable force. The block produced in an overfilled mold still will not be dense enough. The builder can judge when he has the correct amount of mix in the box: He will feel the greatest force when the end of the lever lacks about one foot from being level.

If weighing equipment is available, you should determine the density of your blocks by measuring their weight and volume. The best blocks are the heaviest or most dense ones.

*EJECTING BLOCKS* - In the CINVA-Ram, blocks are pressed out of the mold by lifting the lever arm and swinging it to the other side of the mold box. After extruding, the block should be transferred to a suitable place for curing. If the top of the block bows or cracks during this extruding process, the soil mix was probably too wet. These blocks will be weak and should not be used. Newly-made soil blocks containing clay can be handled with little fear of breaking. New sandy blocks may crumble when handled, so they should be moved on a wood or metal piece called a pallet. Some fresh blocks must remain on pallets until they are strong enough to be moved. It may be necessary to have enough pallets on hand to handle an entire day's production of blocks. The only way to know whether pallets are required is to make blocks and see how they hold together when they come out of the machine.

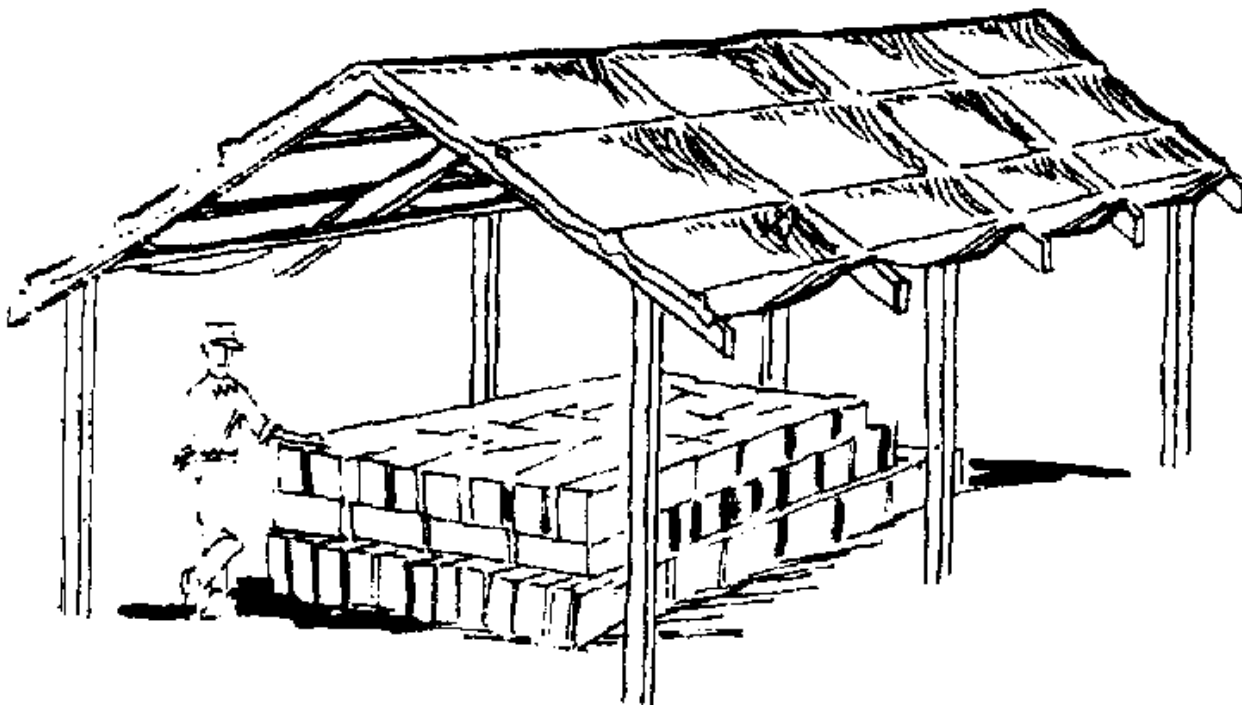

Figure 57.

**CURING BLOCKS** - While curing, blocks should be stored in a place where they will not be disturbed and close to where they will be used.

Curing is completed when the water used for molding is dried out. They will dry out faster in the sun. If the area received a lot of rain, dry them out under a covering or cheap shed as shown in Figure 57. If the roof of the house was built first, dry them under the roof.

A wet cure period is necessary for *stabilized* blocks to gain strength, particularly if they contain cementing type **stabilizers**. (See Chapter 2.) During the wet-curing period, blocks should be stood on end and covered with wet sacking, leaves, or other material as shown in Figure 58 so they can be kept moist. After curing, the covering is removed and the blocks are stacked while they dry.



Figure 58.

Some builders do not wait until the blocks are completely dry before laying them in the wall. This does no harm as long as the blocks do not crack when being laid and do not shrink later. But, let them cure for at least a week before using; the longer the better.

**CHECKING QUALITY OF BLOCKS** - When a large number of blocks is being made, a few bad ones are bound to turn up. Sometimes, even a whole batch of blocks will be of poor quality because somebody did something wrong. Mistakes happen, and the builder can guard against them by performing occasional control tests. The type and number of tests that should be performed depend on the size of the job and type of construction. For pressed earth blocks the following tests are recommended:

1. *The moisture content* of each separate mix should be checked before blocks are molded. If the mixes are small, you can check moisture by making a ball of the moist mix as described in Chapter 2 and dropping it on a hard surface. For large mixes try to use the more exact tests for moisture described in Appendix B. Use soil samples

weighing 1 to 2 pounds.

2. *Spray tests* should be performed occasionally to see if the resistance to weathering is as good as expected. These tests should be performed on cured blocks using the procedure described in Chapter 2. If the job is just starting then 2 or 3 (or even more) bricks out of the first 100 bricks should be checked. Later it is sufficient to check one brick out of every 150-200 bricks made.

3. *The strength* of the block should also be checked often to make sure that the block will be as strong as expected. These tests should be performed on cured blocks using the procedures given in Chapter 2 or Appendix A. The number of tests that should be performed is the same as given above for the spray tests.

4. *Absorption tests* can be easily performed on cured blocks using the procedure given in Chapter 2. Make an absorption test each time you do a spray test.

5. *Density tests* to determine whether your blocks are being pressed enough should be done if weighing equipment is available. Remember that the heaviest blocks are the best ones.

If the blocks do not pass these control tests, block-making should be stopped immediately until the trouble is located.

## **Chapter 10: Making walls with earth blocks**

Earth blocks, whether adobe or pressed, are laid in level layers (or courses) just like ordinary burnt bricks. Each course is offset one-half of the width of the block as shown in Figure 59 so that the vertical joints are not continuous. The blocks are joined together with a mortar to give a uniformly strong wall. Some block-making machines produce blocks with interlocking grooves and ridges so the blocks bond together without using mortar. This type of bond is not very satisfactory, particularly for areas subject to earthquakes or high winds.

The selection of a correct mortar is an important step, and the information given below should be closely studied before a mortar is selected.

*MORTARS FOR PRESSED EARTH BLOCKS* - The mortar used for pressed earth blocks may be one of high-quality like that used for burnt bricks, or it may be made from the same soil mix used for the earth blocks. Here is one high quality mortar that has been successfully used with many different types of earth blocks:

1 part portland cement.

1 part lime.

6 parts clean sand (particle size less than 1/8").

Sufficient clean water to make a workable mix.

If masonry cement is available, use one part masonry cement, three parts sand and enough water to form a workable mix.

If soil mix is used for the mortar it should be one low in clay content to avoid shrinkage cracks. Since the mortar is not pressed like the blocks, it will require some sort of stabilizer - usually portland cement or lime - so it will have approximately the same strength as the blocks. Research has shown that mortar for stabilized pressed blocks should contain about twice as much stabilizer as the blocks to be as strong as the blocks. In other words, double

the amount of stabilizer you used for your blocks when making a stabilized soil mortar.

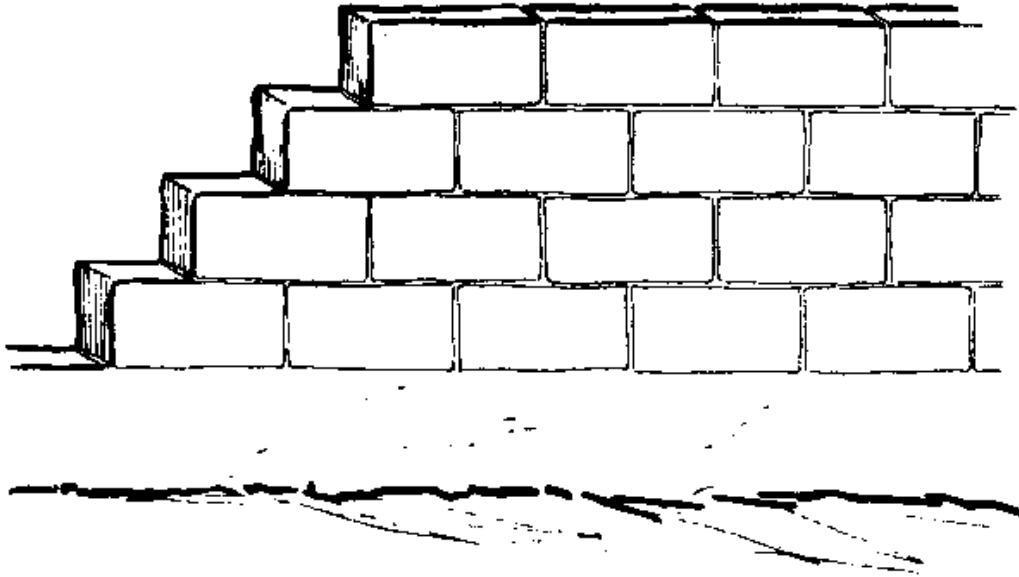

Figure 59.

The soil mix or sand to be used in the mortar should be sieved through a small screen.

*SELECTING THE BEST MORTAR FOR PRESSED EARTH BLOCKS* - There are some simple tests that can be used in selecting a good mortar. Before making these tests, it is first necessary to know something about laying blocks. Since pressed earth blocks are usually dried before they are laid, they are likely to absorb some of the water from the wet mortar. If they absorb too much water from it, the mortar will dry out too fast. Then it will be weak and will not form a good bond with the block.

A simple way to determine if this will happen is to draw a 1-inch diameter circle on the surface of a block with a wax pencil or crayon. Using some sort of dropper, rapidly place 20 drops of water inside the circle. If the block completely absorbs the water in less than 1 ½ minutes, the blocks need to be wetted. This can be done by completely immersing *stabilized* blocks in water for a minute or two. *Unstabilized* blocks can be thoroughly sprinkled with water. Allow the surface water to be absorbed into the blocks before the mortar is applied.

After the blocks have been properly wetted, two or more of them are joined together with each of the proposed mortar mixes using the same thickness of mortar joint that will be used in the wall. It is important that the consistency ("wetness") of the mortar mix be the same as if it were being used in a wall. The excess mortar is removed or "struck off" and the mortar joint allowed to dry at least one day. The mixes are judged from the appearance of cracks in the mortar. A mortar is unsuitable if it contains open cracks that will allow surface water to enter the joint. Fine hairline cracks in the surface are usually not damaging. Mixes that have damaging cracks need either more sand or more stabilizer.

If the test joint you made shows no cracks, set the test blocks aside in a protected area for at least 7 days. If portland cement or lime is used as a stabilizing agent they should receive a wet cure for the first day. At the end of the 7-day drying period, drop the joined blocks on a hard surface from shoulder height so as to land on the corner of one of the blocks. The fragments are inspected to determine if the cracks follow the joints or cross the joints through the blocks. Any mortar that is strong enough to hold the blocks together so that some of the cracks are through the blocks is a strong, durable mortar.

If the cracks are all in the mortar joints, the mortar may be suspected as being too weak for successful use. Some

blocks are extremely strong and may not crack through the block. In such cases, the only thing to do is to estimate by some other means the force required to pull the blocks apart.

*MORTARS FOR ADOBE BLOCKS* - Tests have shown that the mortar for adobe blocks should have about the same strength as the blocks themselves. If the mortar is much stronger than the blocks, it could cause the blocks to crack when it shrinks. For this reason, it is usually best to use the same soil mix (including stabilizer) as was used for the blocks. This mix should be put through a fine screen to remove large particles which are never desirable in the mortar.

If the mortar does not satisfactorily bond the blocks, it may help to wet the blocks first by sprinkling them. Adding a small amount of stabilizer might also help. However, as a general rule, very little trouble is experienced with mortars for adobe blocks.

*SETTING DOOR FRAMES* - Before the block-laying begins, all door openings should be accurately located and marked on top of the foundation wall. Sometimes the door frames are set in place before laying the blocks.

Another satisfactory method, often used with adobe construction, is to leave an accurately measured opening for the door frame to be placed after the block laying is completed. If the door frames are placed first, great care should be taken to make sure that they are in the correct position. They should be perfectly plumb and then solidly braced. The frames should be perfectly square (do this by measuring across the diagonals) and then braced diagonally also.

*TERMITE PROTECTION* - In certain areas of the world, especially in tropical climates, termites or white ants are so bad that they will even burrow in earth blocks. If the house is being built in such an area, special precautions must be taken. The common method is to use a thin metal shield which is placed on top of the foundation wall and have it project out and down from the wall at least three inches. It may also be advisable to treat the soil and lumber with suitable insecticides to minimize attack by termites.

*LAYING THE BLOCKS* - After the correct mortar mix has been selected and the termite shields and door frames are in place, the blocks are ready to be laid. The usual procedure is to place the first layer of blocks around at least most of the house as shown in Figure 60b. Leave space for the mortar in the joints, but do not put it in. This step provides the correct block spacing for the remaining courses. When proper spacing has been obtained by trial the blocks are then laid with mortar.

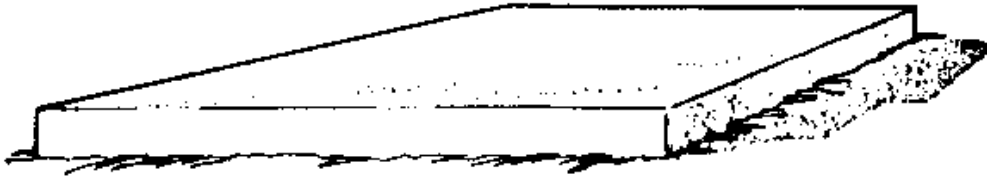

**Figure 60a.**

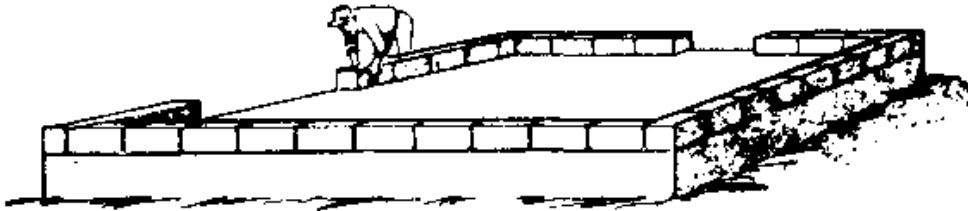

**Figure 60b.**

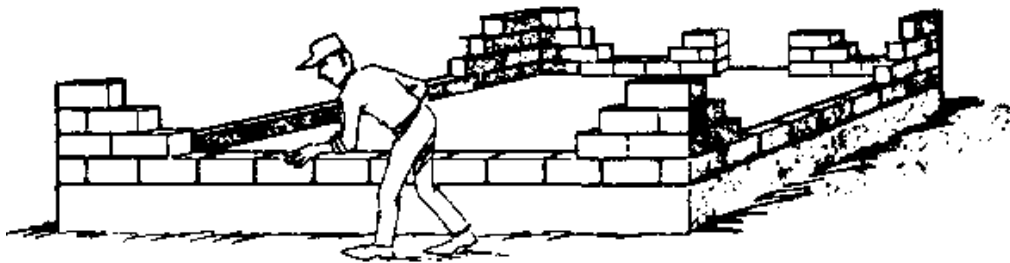

Figure 60a; 60b; 60c.

Then several courses of blocks are carefully laid at the corners and at the door frames as shown in Figure 60c. These provide a guide for laying the remaining blocks, so they should be rayed level and correctly spaced. String lines are then stretched between corners of the building as shown in Figure 61 or between a corner and a door frame. The string line should be placed so that it will just be level with the top of the next row of blocks to be laid and checked to see if it is level. If an adjustment is needed, it should be made. It is best spaced a small distance out from the outside edge of the wall (usually about 1 inch). In this manner, the person laying the blocks knows exactly how far the block should be from the string line to give a straight wall. (It may be handy for him to have a small block of wood of just the correct thickness so that he can measure the distance from the string line to the face of the block.) The string line is moved up to the next course after a course is completed. In this manner the courses are brought up to the level of the window sills. Then the block laying is stopped while the window frames are set in place.

Adobe blocks have rougher surfaces and it will be a little harder to lay them to a straight line but it can be done.

A house with crooked walls will not look as good, so check often to be sure that your walls are going up plumb (vertical). Use a level or plumb bob to check them.



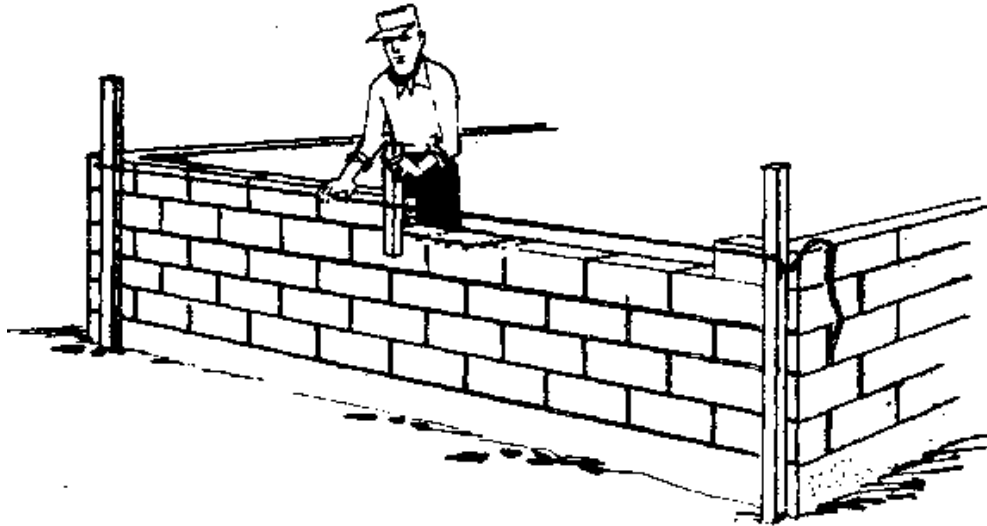
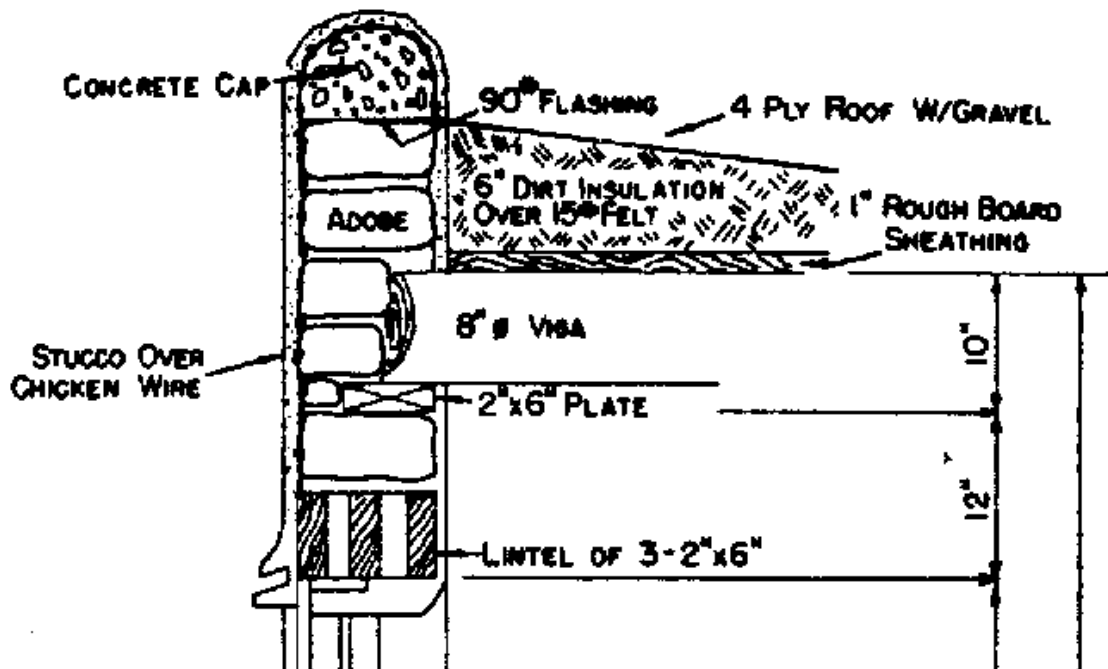

Figure 61.

The block layers (or masons) should have helpers to keep enough mortar mixed, to soak the blocks (if needed) and to keep a supply of blocks easily available to the mason at all times. The mason needs the correct tools for his job, a large and small trowel, a jointing tool, hammer, and level.

The mortar is placed on top of the blocks with the trowel. Sufficient mortar is used to give a joint somewhat thicker than desired. The mason then puts mortar on each end of the block and sets it in place. Using the trowel handle, he lightly taps the blocks into the exact position and then strikes off the excess mortar which has been squeezed out of the joints. After the mortar has become slightly hardened (in about 30 minutes) the mason finishes the mortar joints. This is done with a rounded tool called a jointing tool, which slightly indents the joints and removes rough edges. This serves to pack the mortar tightly in the joints and also makes the joint more waterproof. The mason's helper should occasionally sprinkle the fresh joints with water to keep them from drying too fast. When the mason needs half blocks at door frames and windows he can cut blocks by giving them a sharp tap with the edge of his metal trowel.



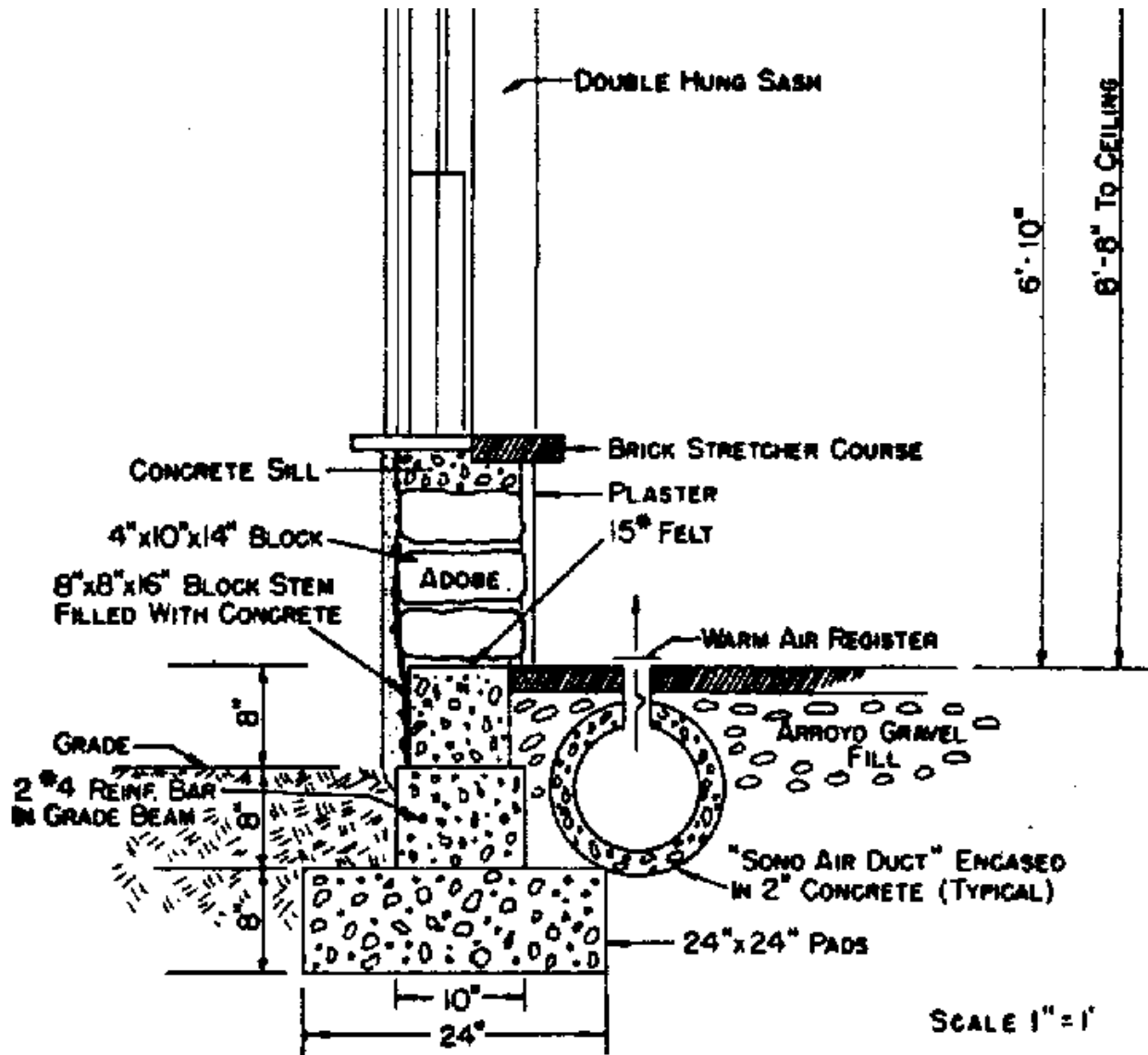
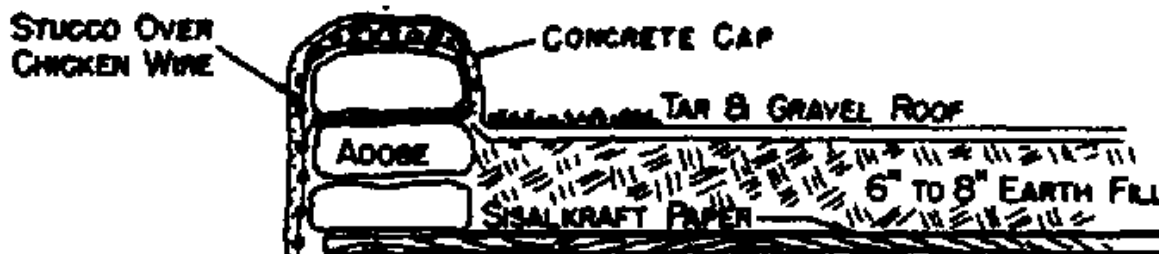
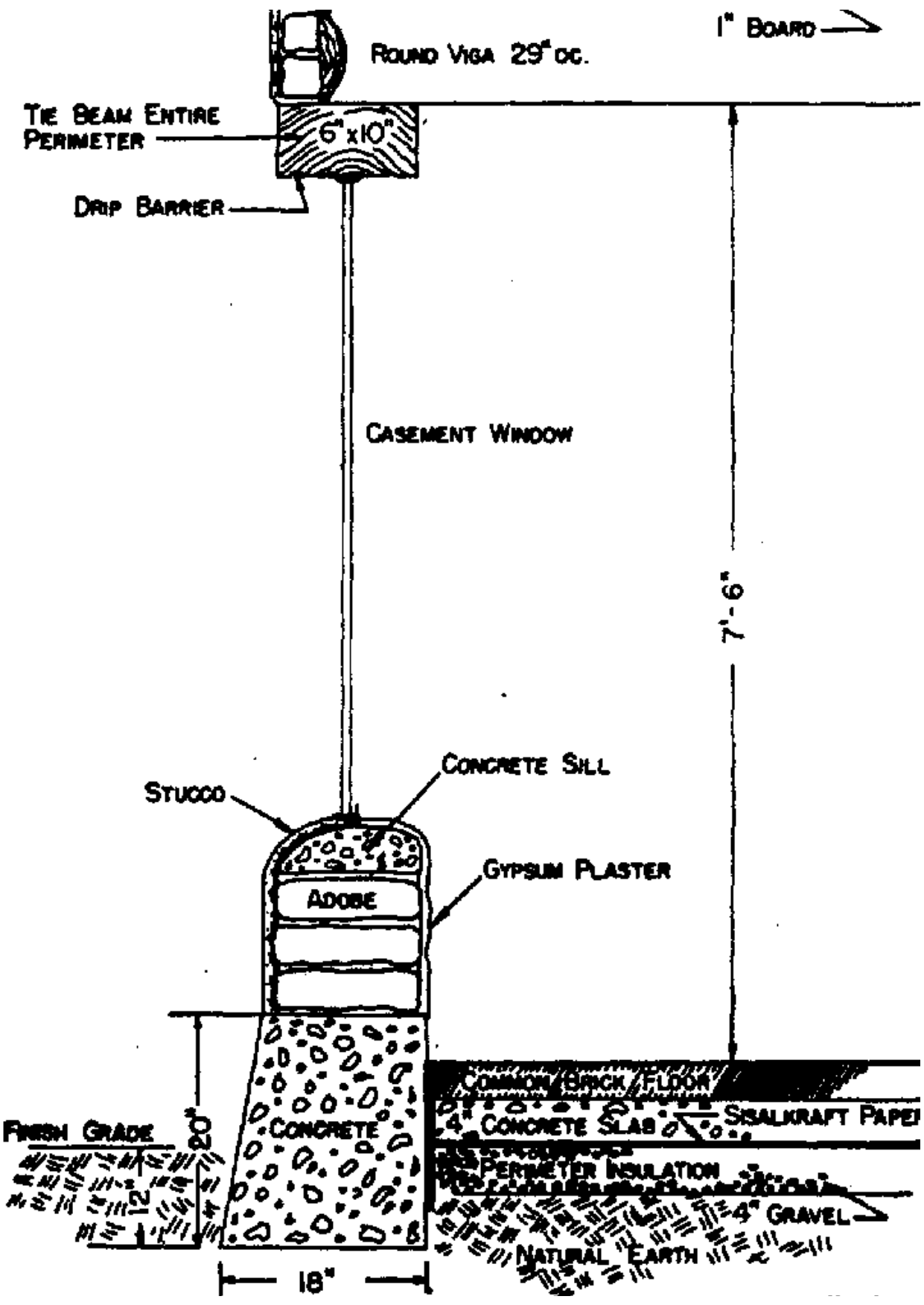

Figure 64. A builder in Albuquerque, N. M., uses this wall section for adobe walls.

If the block wall is going to be covered with a thick surface coating, (as explained in Chapter 13) it is not necessary to finish the mortar joints with the jointing tool. Instead the mortar is left in a rough condition, either protruding out from the blocks or deeply indented. Some builders even omit the mortar from the vertical joints at the ends of the block. This, however, may not be a good idea but if it is done and if this space is later filled with the surface coating it provides a very strong bond between the surface coating and the wall. Rock chips set in the wet mortar, also provide a good bond for surface coatings. This method is shown in Figure 63 for an adobe house.





SCALE 1" = 1'

Figure 65. This typical wall section for adobe is used by a known Albuquerque, N. M., adobe building contractor.

*WINDOWS* - When the block wall has been brought up to the correct height, the window sill should be placed. This is one of the most common places for annoying leaks to occur and great care should be taken at this stage of the construction. The sill should be made of a sturdy material that will not rot. A good quality mortar can be used or preferably lightly reinforced portland cement concrete should be formed into a sill as shown in Figures 64 and 6a. When a wood frame window is to be used, the masonry sill should not at any place extend above the bottom of the wooden sill or leaks will occur. The masonry sill should not stick out beyond its finished outside wall. An overhanging sill will collect water running down the face of the wall and cause damaging erosion. If an overhanging sill is used, it should have a drip groove underneath to prevent water from running down the face of the wall.

After the masonry sill is in place the window frame can be set and braced in the same manner as the doors. Then, the block-laying can continue. Of course, you can also leave an accurately measured opening for the window and place it after the blocks have been raved. A trick often used by adobe builders when the walls will be covered with a surface coating is shown in Figure 67. Wooden nailer blocks - exactly the size of an adobe block - are placed at several points adjacent to door and window openings. The nailer blocks are mortared in place and their center is filled with mortar, also. Window and door frames can be nailed directly to these without fear of cracking adobe blocks. This method can also be used with pressed block walls that will receive thick surface coatings. Another and perhaps better method is to attach sheet metal strips to the frame which will extend into the mortar joints.

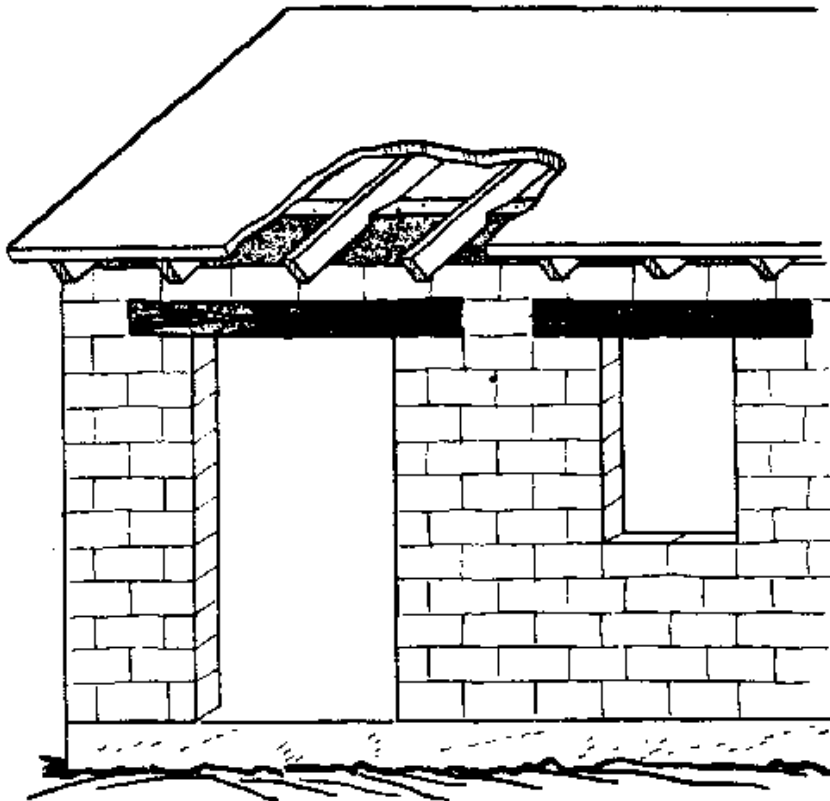

Figure 68. This shows how timber lintels are used above doors and windows. Above the lintels (in the cut out section) is shown a concrete bond beam.

*LINTELS* - The weakest spot in any house is over the doors and windows. A beam or other reinforcing cross piece called a lintel should always be used above these openings as shown in Figure 68. The lintel must be strong enough to support construction loads as well as the weight of the blocks above. A large timber or a reinforced concrete beam makes a good lintel. (Fig. 95 in Appendix A gives some thicknesses of lintels that can be used for various conditions.) The lintel should be at least as thick as the wall so that blocks laid on top of it will be fully supported. They should also project out on either side of the door or window for a distance at least equal to the thickness of the wall so they will have plenty of surface to rest on.

A drip barrier should be cut in all lintels. This barrier is a small groove (about  $\frac{1}{4}$ " deep and  $\frac{1}{4}$ " across) on the underside of the lintel about one inch from the outside edge. It will keep water from seeping back into the wall, itself. Figure 65 shows the location of the drip barrier.

This method was commonly used over a hundred years ago when this building was constructed, and it's still a good one. Railroad ties also make good lintels because they are strong and usually are treated to resist termites.

*BOND BEAMS* - Bond beams (sometimes called tie beams or perimeter beams) are used to reinforce the top of the earth wall against loads from the roof. (See Figure 68.) The beam distributes the roof load and ties the top of the walls together. If a low-ceiling house is being built, the bond beam can also serve as the lintel as shown in Figure 70. Bond beams should be the same thickness as the wall and preferably be tied to the wall with bolts or some other type of projection. The beams may either be wood or reinforced concrete. Wooden bond beams should be placed over a thin layer of mortar on top of the last course of blocks. Concrete bond beams (and lintels also) can be poured in place on top of the completed earth wall as shown in Figure 71. Make the forms strong so they will not bulge. If you are using a timber frame roof, set bolts in the fresh concrete for holding the roof down.

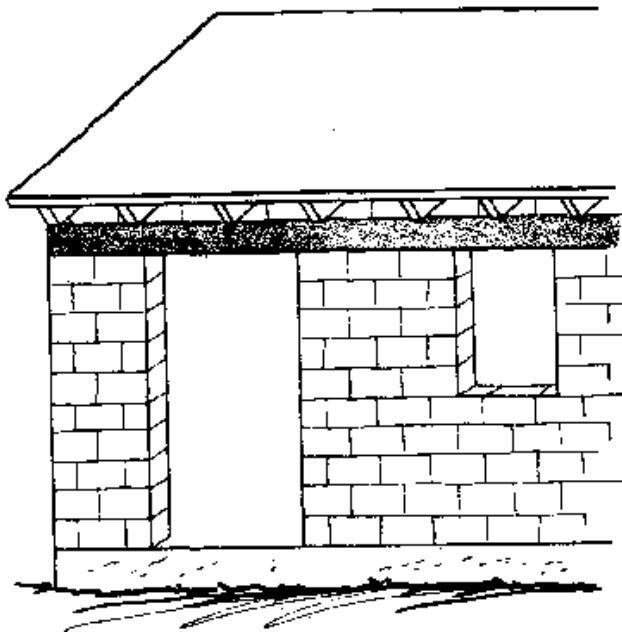

Figure 70. This shows a combination bond beam and lintel, made from reinforced concrete, that can be used, on low-ceiling houses.

*REINFORCEMENT* - The best made homes use extra reinforcing. In earthquake or high wind areas, reinforcing should always be used. The most common type of reinforcing used in a block wall consists of reinforcing rods or

wire mesh laid in occasional horizontal joints. These rods or mesh are embedded in the mortar between blocks and also serve to reduce shrinkage cracking. Usually this reinforcing is placed in at least one out of every six horizontal joints.

Additional reinforcing is normally required in the horizontal joints immediately under window sills. Since a window represents a weak place in the wall, most structural cracks occur at the corner of the window. Reinforcing is not required above the window if a sturdy lintel is used. Reinforcing rods are sometimes placed in the mortar joints at wall corners and where an inside wall joins into an outside wall. This reinforcing can be made from steel bars that are bent to form the shape of the corner of the wall junction.

Additional strength, particularly for a two-story building, is obtained with vertical reinforcing rods. For most block walls this means drilling a hole through the blocks and grouting the rod into the block. Vertical reinforcing is normally used only in areas subjected to severe earthquake shocks.

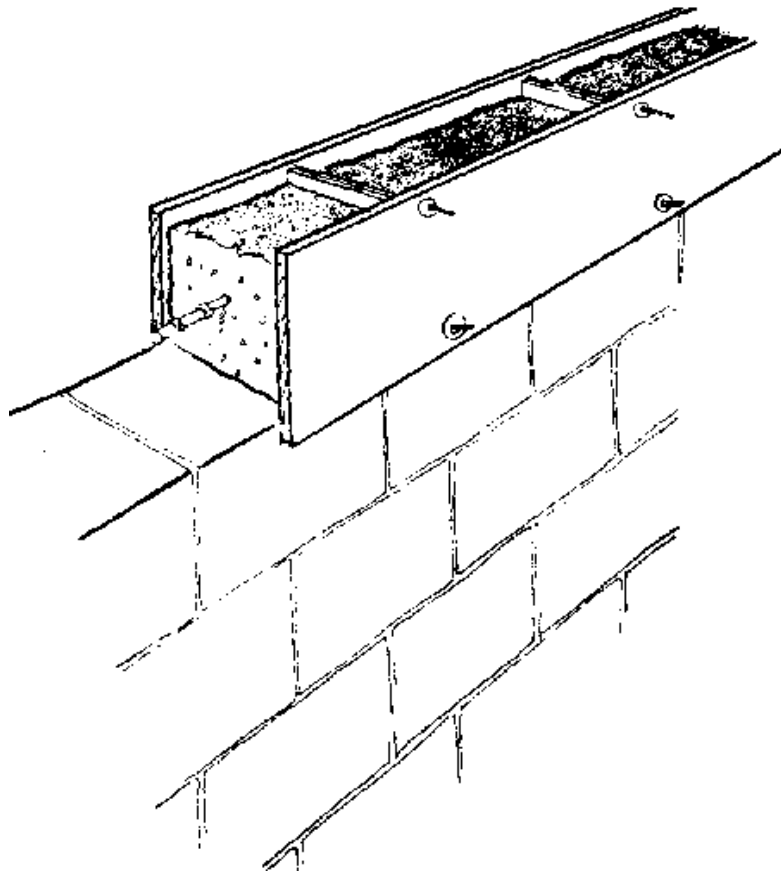

Figure 71. Forms like this can be used to pour concrete bond beams and lintels in place in the wall.

*EARTHQUAKE DESIGNS* - In areas subjected to frequent earthquake shocks, the following rules should be followed:

1. The plan of the building should be compact and rectangular in order to minimize the effects of shaking.
2. A continuous reinforced concrete foundation laid on compacted or solid ground is necessary.
3. One-story walls should not be less than 12 inches thick for exterior walls and 8 inches thick for interior walls. A two-story house should have 18- and 12-inch thickness exterior and interior walls for the first story and wood

framing for the second story. The lighter construction for the second floor minimizes the hazards resulting from earthquakes.

4. Reinforce mortared joints. Reinforcing rods or wire mesh should be placed in every fourth or fifth horizontal mortar joint and lapped over at corners. When surface coatings are used this method can be improved by using a four- to six-foot width of one-inch wire mesh in every sixth joint. The extra width is turned down against the face of wall and fastened to it. This provides a good bond for plaster.

*INSIDE WALLS* - The homebuilder has several choices of materials from which to construct the interior walls of the building. They may be made from the same soil that was used in the exterior walls. Normally they do not have to be as thick nor as strong. Also, they do not need to be weather proof. They should, however, be resistant to abrasion, and a hard plaster coating may be desirable.

## **Chapter 11: Making rammed earth walls**

A rammed earth wall, you might say, is a large pressed earth block. Because it is much bigger than a pressed earth block and it is made right on top of the foundation wall, it is harder to do well. But if you do it right, you will save a lot of effort. You don't have to move a lot of small blocks around and lay them in the wall. A rammed earth wall will make as good a wall as pressed blocks will make.

Don't try to build a rammed earth house without knowing exactly what you should do. It will be worth your while to spend a lot of time studying this chapter before you start.

After finding the right kind of soil for rammed earth, the most important thing to do is to build a form or mold to ram the earth in.

The next most Important thing is to ram the earth correctly.

*HOW TO BUILD FORMS* - The forms for rammed earth are a lot like those used for poured concrete. They are simply rectangular boxes without tops or bottoms into which earth is pounded. The forms must be strong because they will have to stand a lot of abuse before your walls are finished. Since they will have to be moved often, they must not be too heavy for a couple of men to lift.

The forms can be made from metal, but since most builders will want to use wooden forms, we will talk about them only. A simple form can be made like the one shown in Figure 72. It uses 2" thick lumber (2"x6", 2"x8" or 2"x10") nailed to 2"x4" braces or studs spaced 2' to 3' apart. You'll need two panels and several long (about 28"-30") 5/8" round bolts to hold them together. The bolts should be long enough to extend through the forms and studs with the threaded portion sticking out a couple of inches. After the forms are removed, the bolts are driven out of the wall and the holes filled with tightly rammed soil mix.

The form in Figure 72 are used for making straight wall sections. To make corner sections, make some special forms from the same type of wood.

In building a rammed earth wall, the bottoms of the panels are clamped tightly over the foundation wall or a section of finished wall. If they are the right thickness or width, the bottoms of the forms will be right, also. To space the top of the forms, use 2"x2" wood "spacers" cut to exactly the same width as the wall.

To keep the earth from coming out of the forms at the ends, use a piece called an "end gate." End gates should always be as thick as the rest of the forms - 2" in this case. End gates also serve as spacer blocks at the ends of the

forms so they should be as wide as the walls. In most cases end gates will be used right at the end of the forms, but they should be made so they will fit any place inside the forms in case you have to ram short wall sections. Try to space end gates so they'll be at least 8" from the nearest bolt. If you don't leave enough room, it will be difficult to ram the soil correctly.

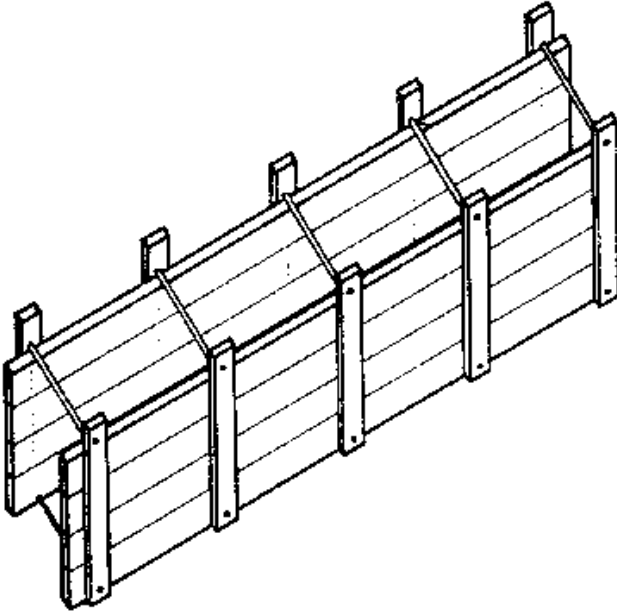

Figure 72. Form for ramming.

Always nail a beveled piece of wood on the end gate so that it faces the inside wall. When the earth is rammed in the forms, the beveled piece will form a groove in the end of the wall. When the next section of wall is rammed, the groove will be filled with earth to form a solid joint that bonds the sections together.

The form shown in Figure 72 will be, fairly heavy for two men to handle. If a smaller form is made, it will be lighter, of course, but you will have to move it too often.

Plywood, 1" thick, will do as well as 2" planks, and will make lighter forms. It must be braced better, though. Use 2"x4" studs spaced 18" apart in both directions. The bolts should be at least ½" in diameter.

Plywood is easiest to use in making forms, but it is more costly than ordinary lumber and sometimes is hard to get. It will make nice, smooth walls, but it gouges easily if accidentally struck with the corner of the rammer



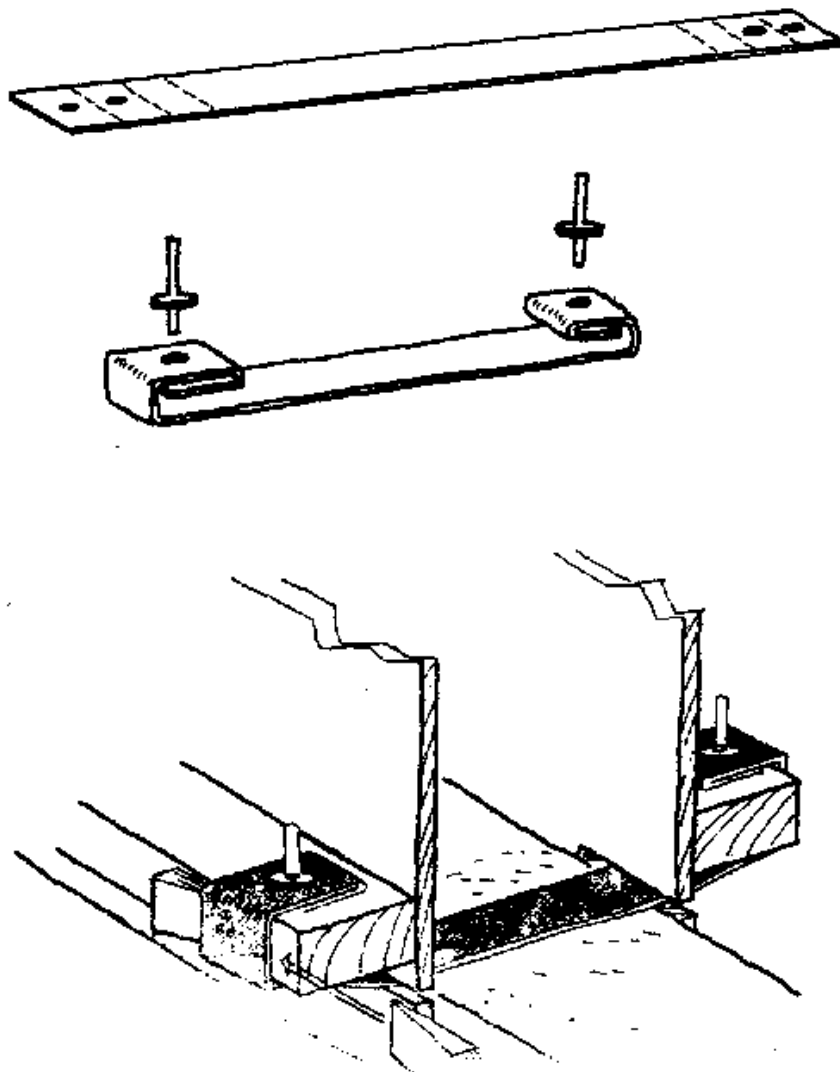
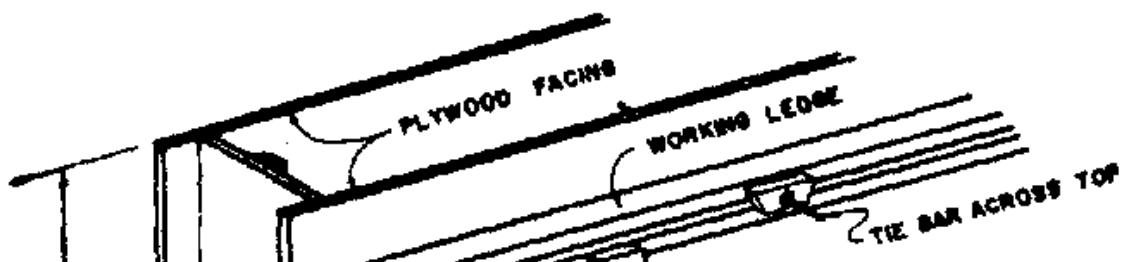
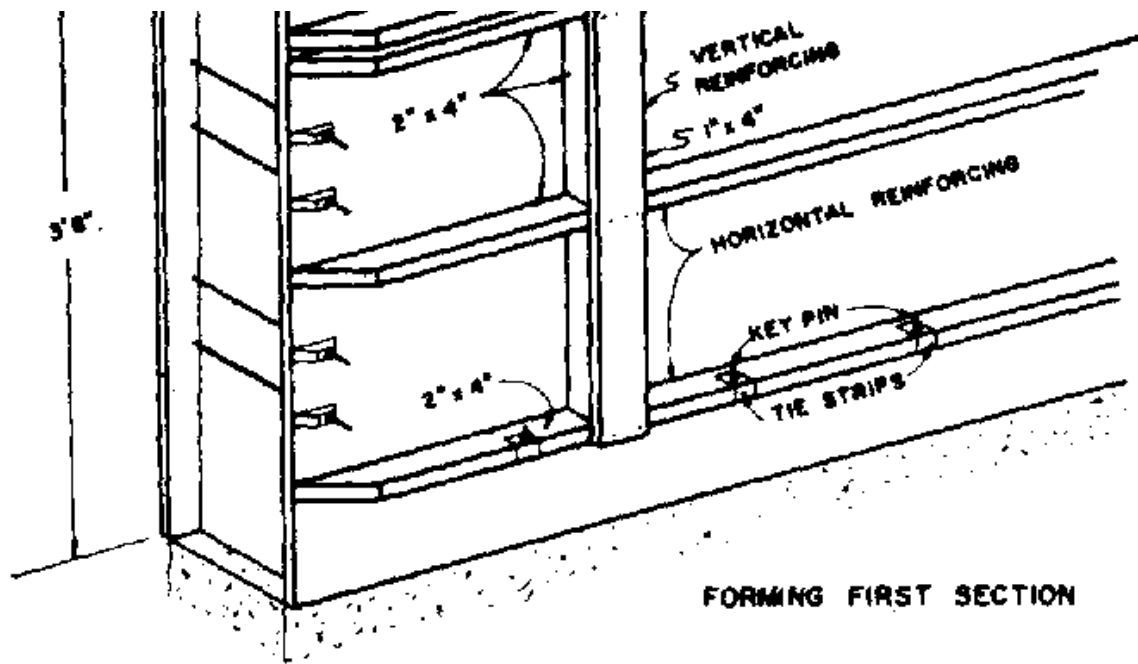

Figure 75. Thin metal strips such as these can be wed instead of bolts to tie rammed earth forms together.

Other thicknesses of lumber can be used, of course. Bolt and stud spacing can be based on those shown in Figure 72.

Instead of bolts, which might be hard to get, you can use thin metal strips to hold the forms together. Small slots are cut in the forms for the metal strips to go through. Metal peg, or large nails hold the strips to the forms and wedges can be driven to pull the strips tight as shown in Figure 75. Instead of pulling the metal strips out of the wall as you do with bolts, just leave them in place. If you are going to use a plaster surface coating leave them sticking out a short distance to bond the surface coating to the wall. If not, cut them off flush with the surface of the wall.





FORMING ADJACENT SECTION

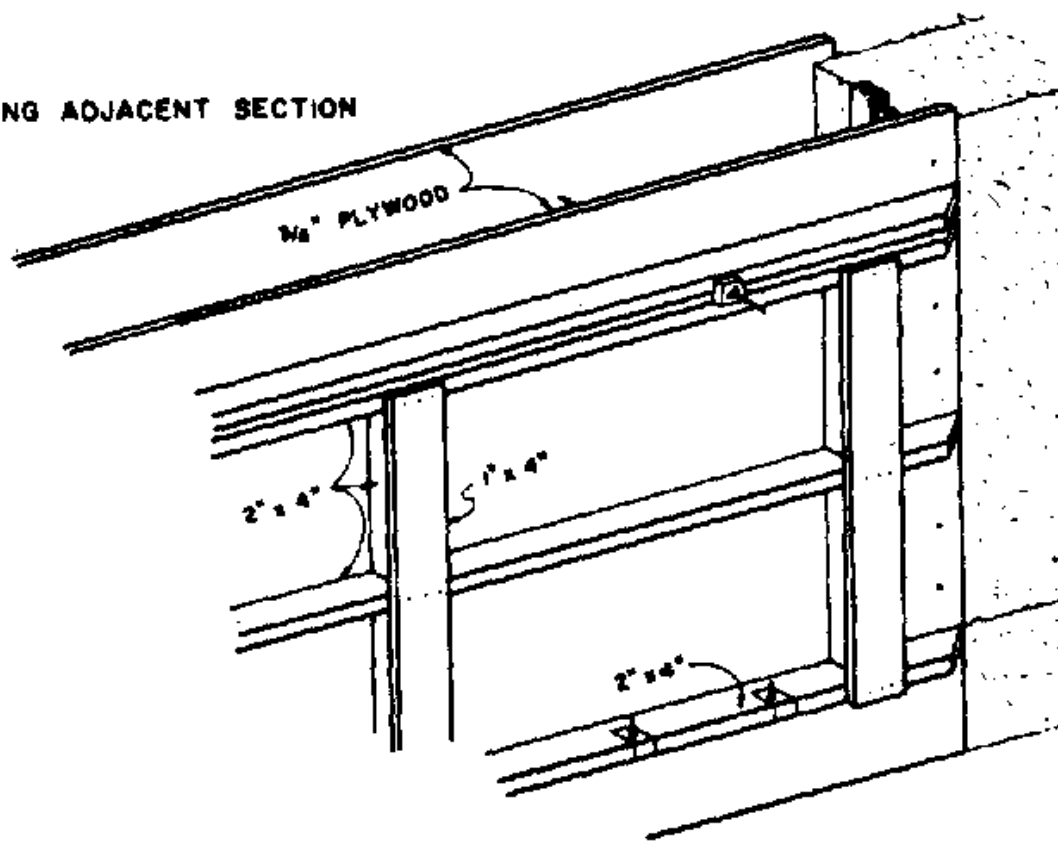

Figure 76. This is a special form that was designed to use the metal de strips shown in Figure 75.

Of course, if you use strips, you will need many, but they are not costly. They can, be cut from thin pieces of sheet metal or even from heavy metal cans. A form that has been especially designed to use these metal strips is shown in Figure 76.

Another type of form that has been used is shown in Figure 77. The top bracing and rods are strong enough to hold the bottom of the form together. You'll need only a few bolts and you don't have the bother of removing the bolts from the wall. But the forms are harder to make and they also must be sturdier. Don't try them unless you are an experienced builder.

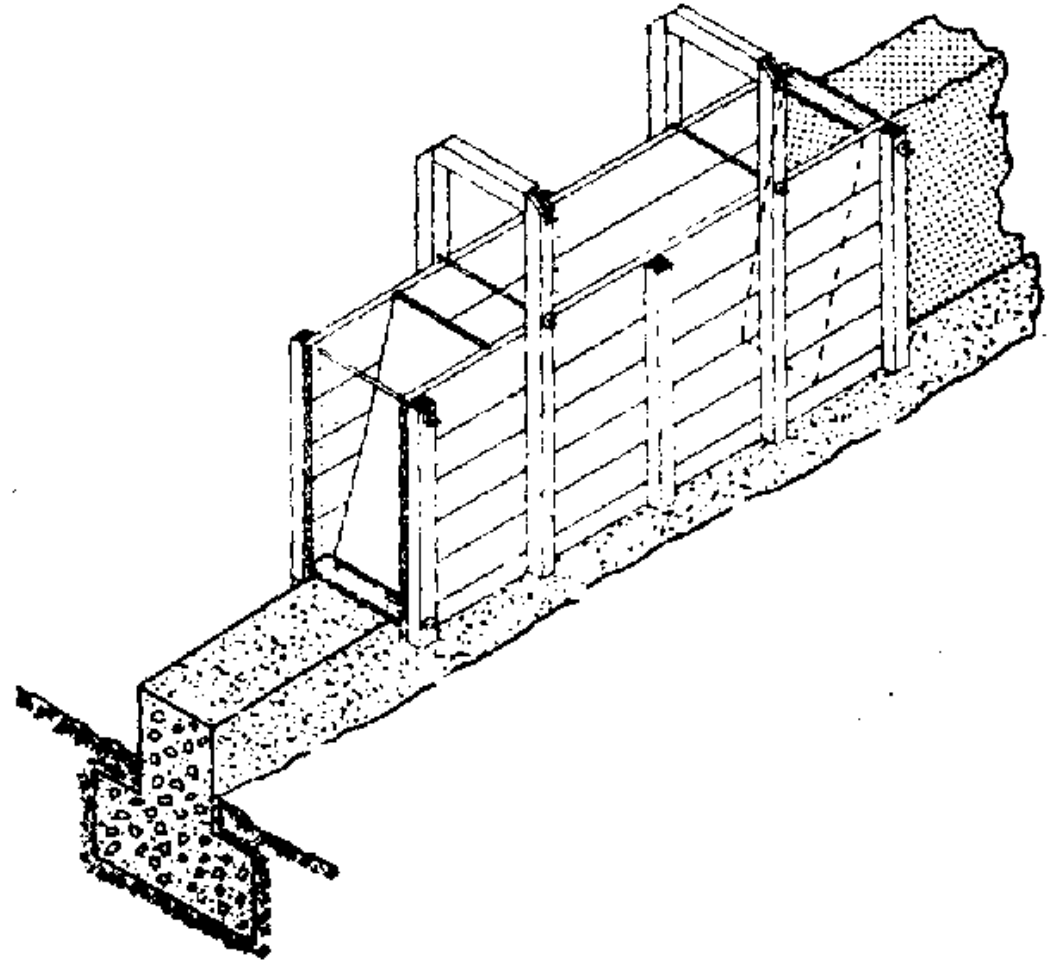
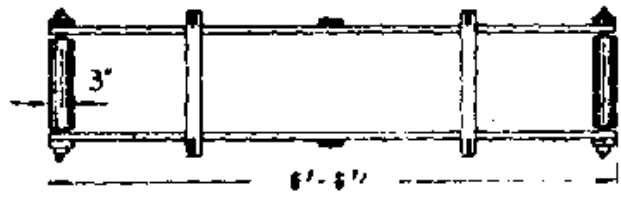
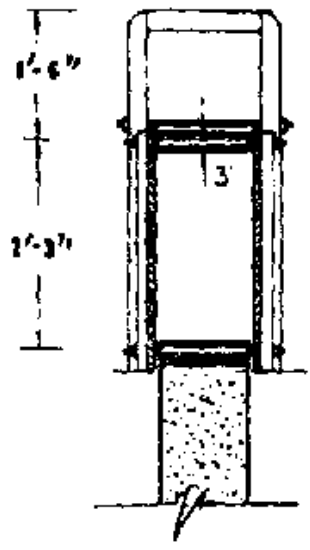
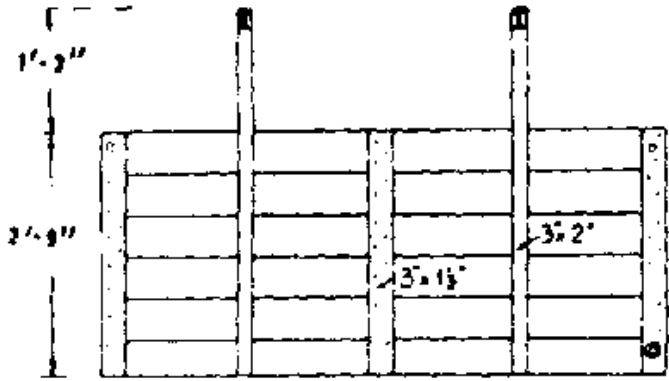

Figure 77. Form for ramming.

Here are some hints that might help you when you make forms:

1. Don't make your forms deeper than 2 or 2½ feet. If they are deeper, it will be difficult to ram the earth correctly at the bottom of forms.
2. Use seasoned lumber for your forms. Green lumber will warp.
3. Keep your forms oiled with a light-weight oil. This will stop warping, and keep the soil from sticking to the lumber.
4. When your forms are not being used, stack them flat in a protected and well-drained area so they won't warp.

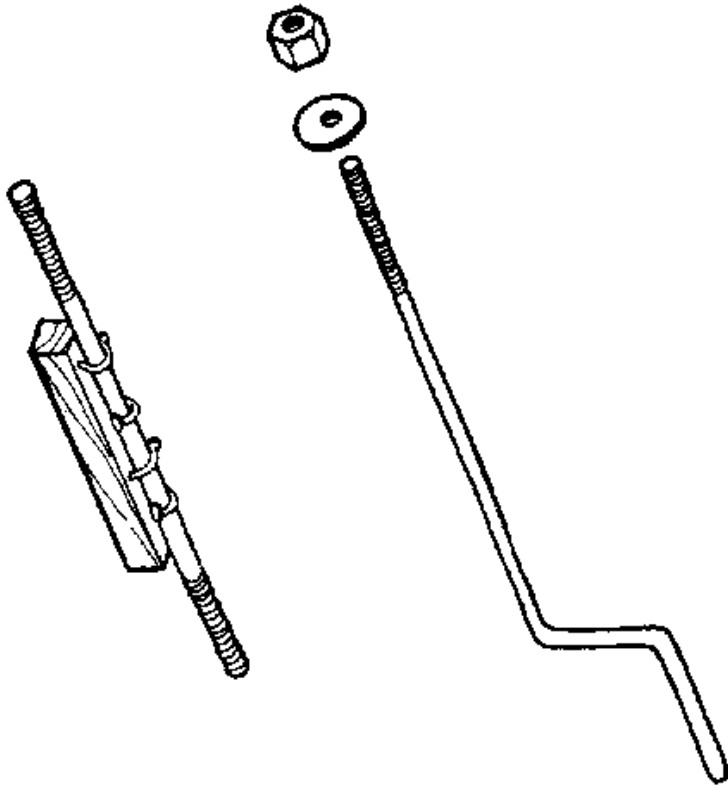

Figure 78.

5. Make your bolts with crank-type handles as shown in Figure 78.
6. You can crank the bolts off and on faster than you can tighten the nuts with a wrench.
7. If several houses are being built, line the inside of your forms with thin sheet metal. They will last twice as long.
8. Drive a couple of nails partially in your spacer block and bend them over to fit on the bolts as shown in Figure 78. When you set the forms up, stick the bolts through the nails to hold the spacer blocks in place while you are tightening up the bolts.
9. If you can't find suitable bolts, use heavy wire to hold the forms together. Thread the wire around the studs and

twist it tight with a rod or heavy nail. When the forms are removed, cut the wire off flush with the wall.

10. Every place where you have an unprotected corner, nail a small strip of wood, cut on a 45° angle, to the inside corner of the forms. This is called a chamfer strip, and it will help to "round off" the sharp corners.

### **Rammed Earth Tampers**

Most rammed earth tampers are the hand type, but if you want to tamp soil faster, an air tamper - which requires expensive equipment will be better.

*HAND TAMPERS* - The weight of hand tampers is very important. The heavier the tamper, the faster the earth can be rammed. So use the heaviest tamper your laborers can handle all day long without overtiring. Small laborers cannot lift hand tampers weighing more than 16-18 pounds for long without tiring. Larger men may be able to work efficiently with tampers weighing 20 to 30 pounds.

The size of the striking face is regulated depending on the weight of the tamper. A good rule to follow is this: the tamper should weigh two pounds for every square inch of tamper face. A tamper with a 3"x3" square face (this is the most popular size) should weigh 18 pounds. For a 4"x4" square face the tamper should weigh 32 pounds.

A square tamper with a flat striking face is the best to use. Round-shaped and other curved faces may not gouge the forms as badly as square ones, but they don't compact as well, either. If you care to, you can make a few tampers with special shaped faces for compacting in small areas, such as around the end gates of the forms.

Figure 79 shows a sturdy metal tamper that is easy to make. Tampers can also be made of wood but they are a little harder to use because they are bulky. The striking face of wood tampers should be covered with a piece of metal to prevent rapid wear and splitting

This hammer can be guided easier and therefore it does not damage the forms as much as a one-man tamper.

*AIR-TAMPERS* - With an air-tamper one man can tamp soil in one-half to one-third the time that he could using a hand tamper. Many types of air-tampers are available. Get a light one that doesn't weigh more than 25- 30 pounds. It should be a long-stroke machine, of moderate feed, that delivers powerful blows. A six-inch square tamping face can be used with this type of machine.

A constant air pressure of approximately 70 pounds per square inch is necessary. An air compressor with a free air delivery of 24 to 30 cubic feet per minute will operate one tamper

*THICKNESS OF TAMPED LAYERS* - A good rammed earth wall should be well tamped from top to bottom. Layers which are placed too thick will be loose at the bottom and will wash out during rains. The thickness of each loose layer of earth before tamping should not be more than 1" more than the width of the tamping face. For example, don't try to tamp more than 4" of loose soil with a 3"x3" square-faced tamper. After tamping, a 4" loose layer should be approximately 2½" thick

*CONSTRUCTION PROCEDURE* - The construction procedure for rammed earth walls is very similar to that used for earth blocks. The first step is to install the termite shields, if required. Bend them down so they are out

against the side of the foundation wall. Then, place the forms over the foundation wall and draw them up tight against it with the bottom row of bolts, wires, or whatever you may be using. The end gates and spacer blocks are then inserted and the top row of bolts is tightened. You are now ready to start ramming. Figure 80 shows a rammed earth wall under construction.

When a section is completed, the forms are moved, fastened tightly at their new location, and ramming continues. Ram a complete section around the house before starting the next layer. Joints between layers should be staggered like those in pressed blocks so they do not form a single, weak line in the wall. This method is shown in Figure 81.

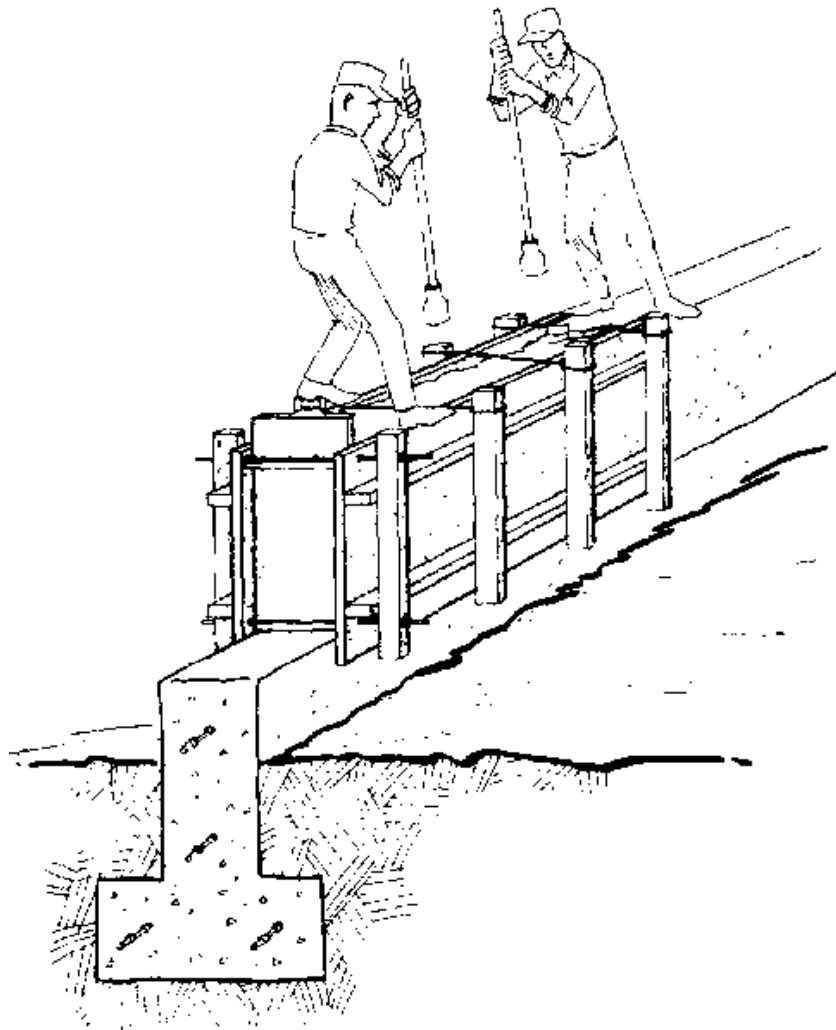

Figure 80.

Figure 81 also shows how the beveled piece of wood on the end gate forms a good vertical joint between sections.

The first sections to be rammed should be the corners of the house. *Particular care should be taken to make sure that corner forms are perfectly plumb or vertical.* This is most important and should be checked often. **RAMMED EARTH WALL THAT IS BUILT LEANING CAN NEVER BE STRAIGHTENED.**

Use string lines stretched between the corners to line up wall forms and assure straight walls. The method shown

in Figure 61 works well, but place the string line slightly above the tops of the forms so it will not touch the forms.

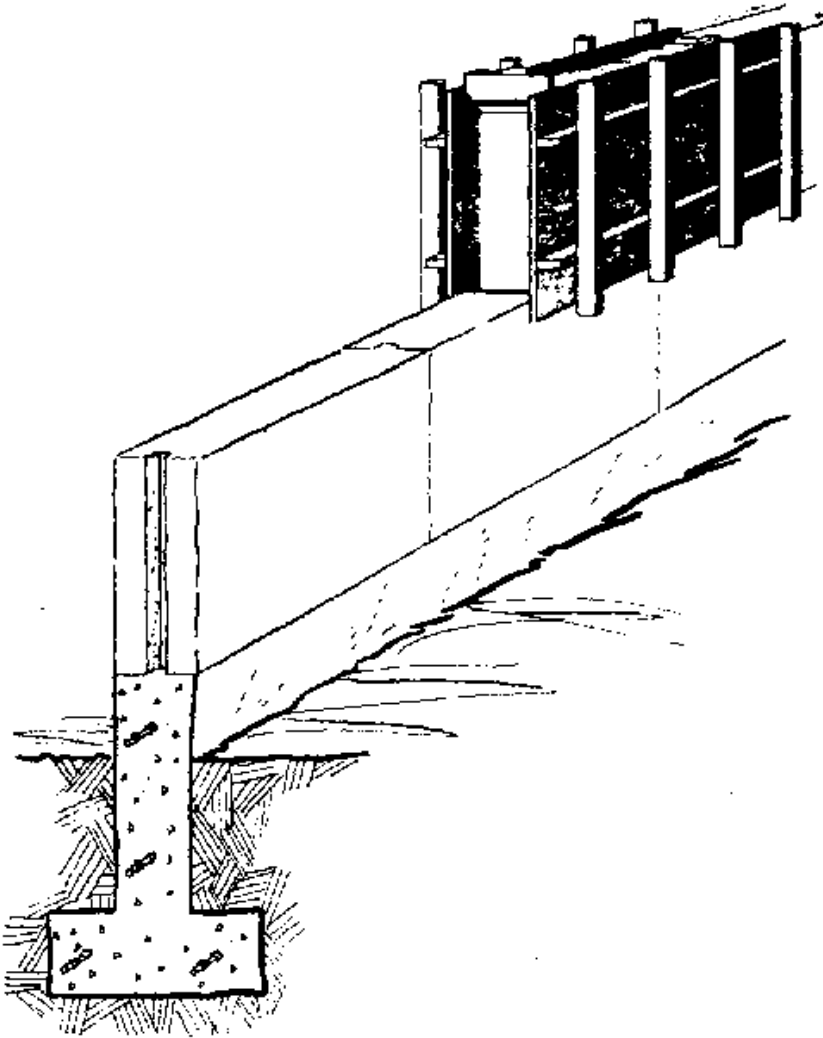

Figure 81.

Protect newly-constructed wall sections until they gain strength. At night and when rain threatens, all walls exposed to rain should be protected with mats, heavy cloth, or waterproof paper. It is very important that this protection cover the top of the wall, since erosion starts there first. Walls stabilized with cement, lime, or other cementing-type stabilizers should be protected and kept moist during the entire curing period. Sacks or mats, moistened several times daily are good for this.

Some soils - particularly the sandier ones - may have a tendency to crumble when the next section is rammed on top of an earlier lift. If this happens, wait until the lower section gains enough strength to prevent this. For soils having cementing-type stabilizers in them, wait 3 or 4 days if possible. In general, you can ram on top of any wall section as long as it doesn't crumble or crack.

Before ramming a new section, scratch the top of the lower completed section about  $\frac{1}{2}$ " deep with a pointed wood or steel stake. If the completed section is dry, moisten the top of it slightly. This will improve the bond between sections.



*NUMBER OF WORKERS NEEDED* - Once the soil mix is prepared, 2 to 4 workers can be used to construct the wall. Two men can do the ramming but, if the forms are short, the work will be more efficient if only one man stands in the forms. One worker is required to shovel the prepared soil mix into the forms. One worker, supplied with soil, can ram about 3 cu. ft. of soil in an hour.

Since the workmen operating tampers stand inside or on top of the forms, scaffolding or supports are not required for them. But as the wall increases in height, scaffolding may be necessary for the worker shoveling soil mix inside the forms. A worker on the ground shovels the mix onto the scaffolding. This requires a total of three or four workers. An alternative is for the man tamping the soil to pull up additional soil as needed in a bucket and pour it into the forms.

Scaffolding or other supports will also be necessary when the wall is high and the forms must be moved around.

*TAMPING THE SOIL* - REGARDLESS OF HOW GOOD THE SOIL MIX IS, A RAMMED EARTH HOUSE WILL NOT LAST LONG UNLESS IT IS TAMPED ENOUGH AND UNLESS THE MOISTURE CONTENT OF THE MIX IS RIGHT. The two go together, because unless the moisture content is right, the earth cannot be tamped right. For this reason, the moisture content should be checked often, not only when it is mixed, but also when it is being tamped. Mixes which are too wet or too dry should be remixed. Cement-stabilized mixes which have dried out should not be used.

RAMMING SHOULD BE CONTINUED ON EACH LAYER UNTIL THE NOISE FROM THE RAMMING TOOL CHANGES FROM A DULL THUD TO A CLEAR, RINGING SOUND.

Workers operating the tampers have a hard but important job. Their work should be checked often. An easy way to check for soft spots is to shove a sturdy knife blade into various spots in the rammed layer. Soft spots found in this manner should be rammed some more. The important places to check are directly against the forms, in corners, and around beveled strips on end gates.

If the soil tamper will not ring regardless of the number of tamps, then something is wrong with the mix. Probably it is too wet, so check it closely.

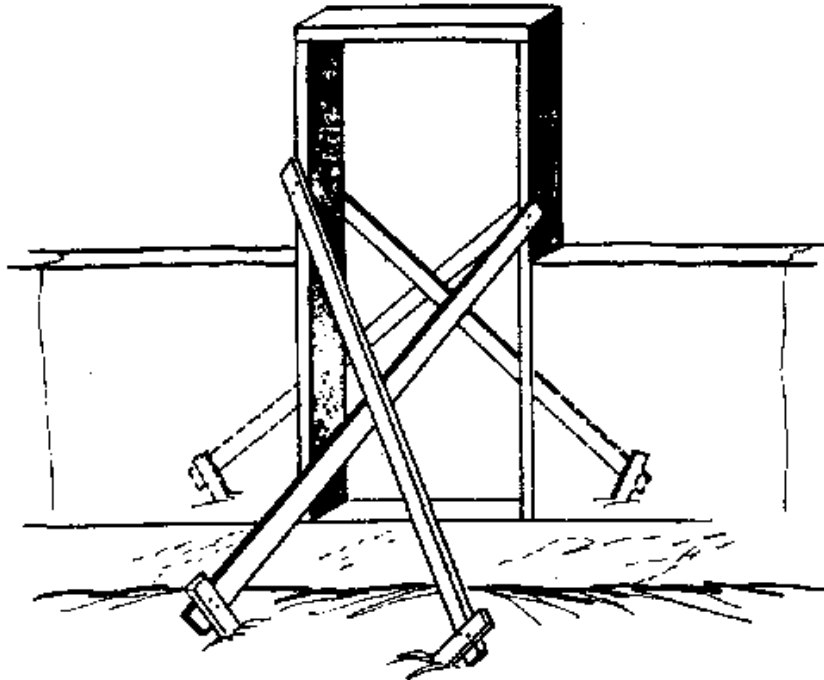

Figure 82.

*DOOR AND WINDOW OPENINGS* - Openings for doors and windows can be done two ways in rammed earth construction. One way is to set the door and window frames first and ram the earth around them. If this is done the frames should be solidly braced as shown in Figure 82 otherwise they will be forced out of place by the high pressures produced by ramming. Brace door and window frames across the diagonals also so the openings will remain square. Frames should be as wide as the walls and should have ties sticking into the wall to hold them firmly in place.

The other way is to ram the earth first leaving an opening in the wall for the frames. When this method is used, the beveled strip is removed from the end gate. The end gate is then accurately positioned at the spot where the opening is to occur. Wooden nailer blocks must be placed in the wall so that door and window frames can be securely attached to them. The blocks are placed on top of a tamped layer and adjacent to the end gate. The next layer is tightly rammed around the block to hold it securely in position. The result is shown in Figure 83. Another method also shown in Figure 83 uses a single piece of timber the full height of the opening. Lightly nail this piece to the end gate so the end gate can be easily removed from it after each layer is completed. When using this method, the door frame does not have to be as wide as the wall, but the unprotected edges of the wall should be chamfered as explained on page 119.

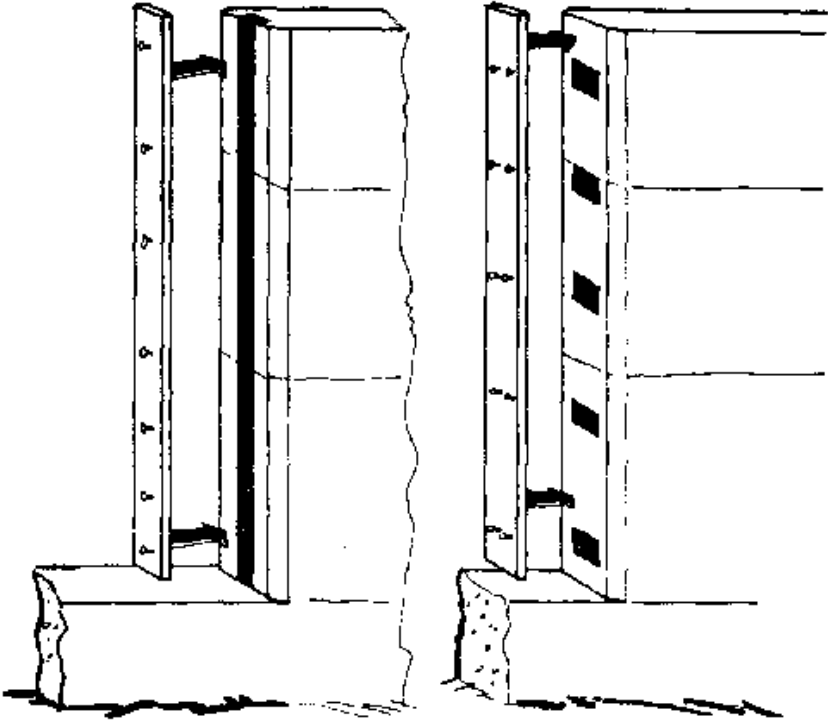

Figure 83.

Sometimes you may run into a situation like this:

You will be ramming against a short section of w 11 (say 3' long) which is adjacent to a window opening. The pressure from ramming against this short section may cause it to slide toward the open space. To keep this from happening, strongly brace the short section against the wall on the opposite side of the opening or against stakes driven in the ground.

If a section does slide, tear it down and ram a new section in place.

*WINDOW SILLS* - For window sills in rammed earth follow the same rules as for pressed blocks.

*LINTELS AND TIE BEAMS* - Lintels and tie beams are constructed in the same way as for pressed blocks. There is one precaution to be noted, however. The pressures from ramming the earth on top of a lintel may be great enough to cause it to break or permanently sag. To keep this from happening, put sturdy braces beneath the lintel during ramming as shown in Figure 84, or design the building so that there is no earth wall over the door and window openings. This method is often preferred.

*REINFORCEMENT* - Barbed wire, woven wire or small metal reinforcing rods may be used to reinforce a rammed earth wall. This is particularly necessary if the building is being constructed in an area that has earthquakes or high winds and is made of stabilized earth. Reinforcing is not as effective in unstabilized earth walls as it is in stabilized material. Reinforcement around door and window openings always strengthens a wall. It eliminates damaging cracks at these points.

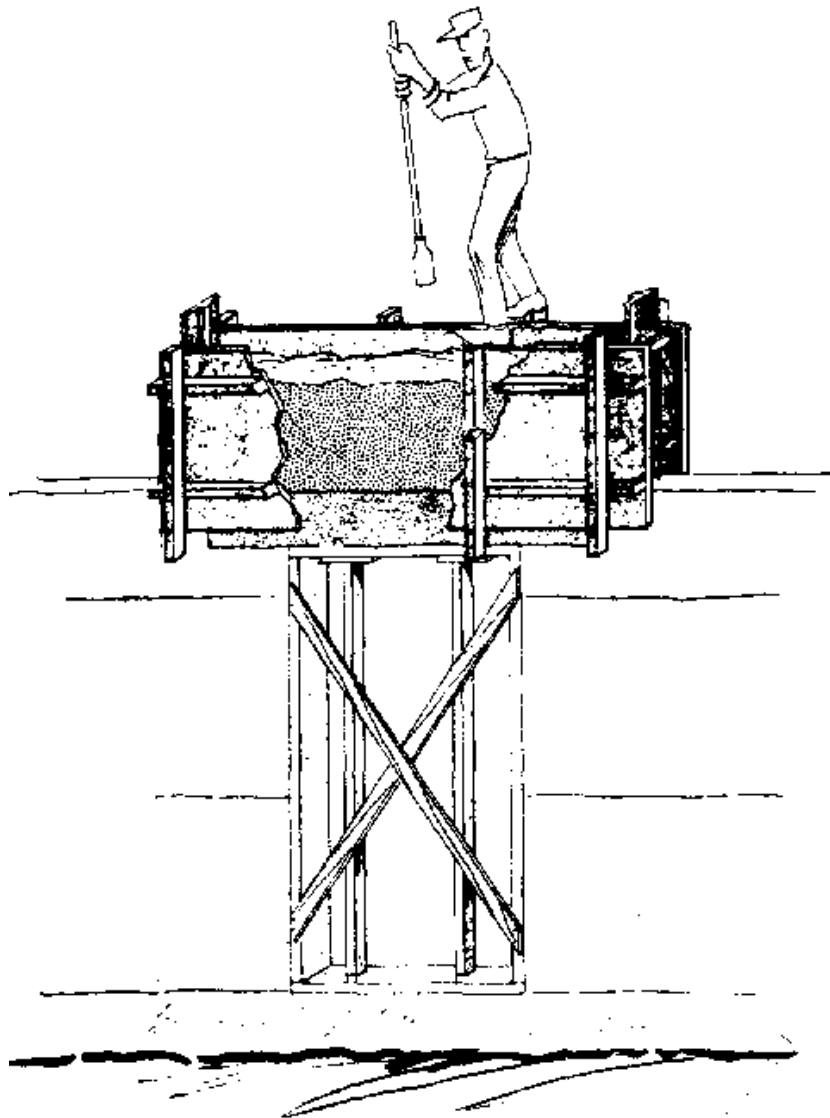

Figure 84.

Reinforcement should be placed no closer than two inches from the outside of the wall. Place it in lengths a little longer than the forms. Turn up the extra length against the end gate so that it can be bent down into the new section after the end gate is removed. Securely fasten the reinforcement in the new section to that extending from the previously compacted section.

## Chapter 12: Roofs for earth houses

Any type of roof used on ordinary houses can also be used on earth houses. Thatch or sheet metal roofs are commonly used. But often it will be cheaper to use an earth roof on your house.

Three types of earthen roofs are used:

1. Bunker fill roofs
2. Arch or vault roofs

3. Frame roofs supporting earthen tiles.

These are things an earth roof must do:

1. It must be strong enough to remain in place;
2. It must not leak;
3. It must provide protection so that water running off the roof will not run down the sides of the earth wall.

*BUNKER FILL ROOF* - A bunker fill roof is a flat roof in which large timbers, (sometimes called "vigas" in parts of the U.S.) support a tamped or compacted earthen blanket. See figure 85. These supports can be sawed timbers or the trunks of small trees, six to eight inches in diameter, spaced approximately 30 inches apart. For large buildings, such as the school shown in Figure 86, large trunks, ten to twelve inches in diameter, can be used. A nice appearance is produced by alternating the large and small ends of the vigas. Also, putting the small ends all in the same direction would cause that end of the roof to be weak. A tilt or pitch is given to the vigas so that the finished roof will slope about  $\frac{1}{2}$  inch per foot of length.

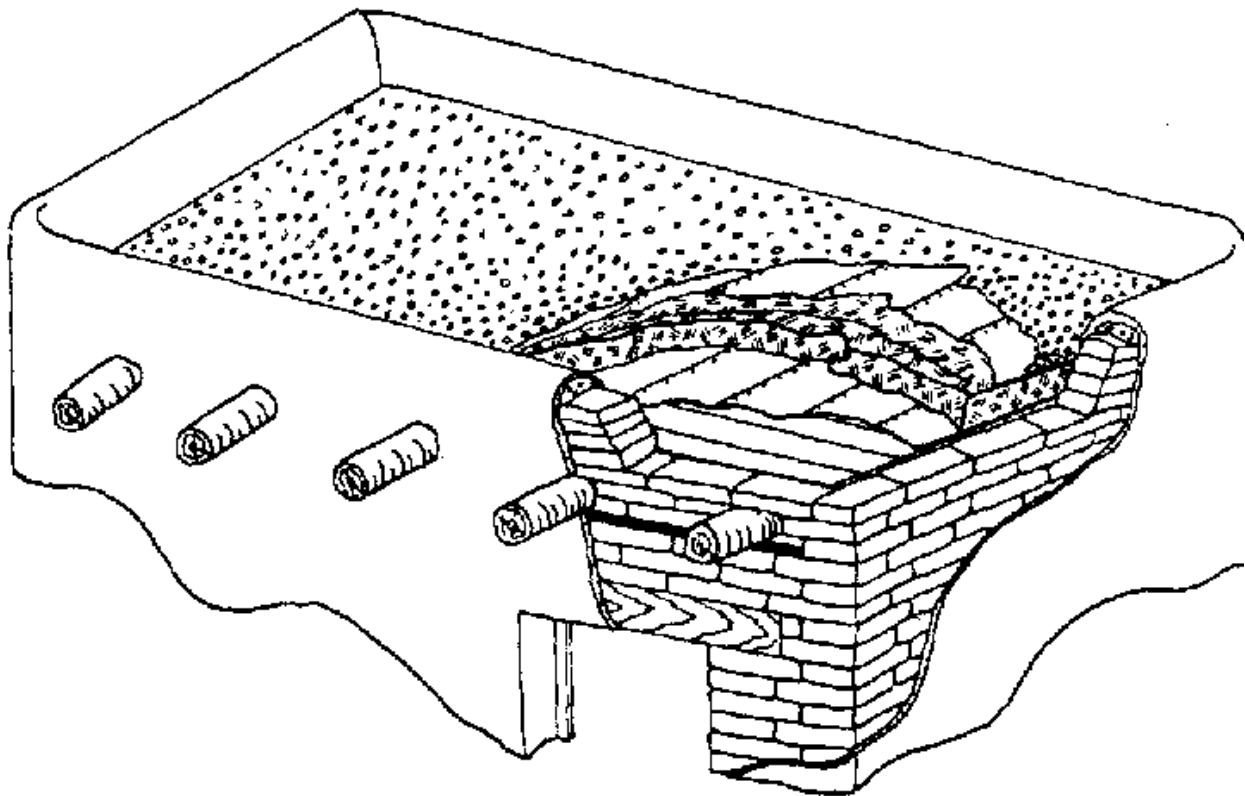

Figure 85. The cutaway section of this bunker fill roof shows the layered structure of the roof. From the top down, the components are gravel and asphalt, building paper, earth fill, building paper, wood sheathing and supporting beams (vigas).

On top of the vigas, place some type of covering to support the earth fill. This can be 1" lumber, some type of reed such as bamboo, or even small saplings. Run the sheathing diagonally from center to center of the vigas.

This will compensate for the unevenness of the vigas. Over the sheathing, use heavy building paper or a thin layer of straw to keep the soil above from seeping through.

A compacted earth fill is placed on top of all this. The thickness, when tamped, should be at least four inches. Deeper fills up to eight inches are better and will increase the life of the roof, reduce the amount of heat going through the roof and lessen the chances of seepage.

The roof should be built up in lifts and packed like rammed earth. The thickness of the loose lift placed at one time depends on the size and weight of rammer used.

The soil type for bunker fill roofs should be similar to that used for rammed earth. Clayey soils will shrink and crack and allow water to seep through. Often, it will pay you to use a stabilizer in your roof material. Lime, cement, or any waterproofers will do. Another way is to add oil or asphalt to the last layer of earth to be compacted. After allowing a few minutes for the oil to penetrate, tamp it into a dense water-tight layer.

A protective surfacing may be needed in climates that get a lot of rainfall. Gravel spread on the top of the surface lessens erosion caused by rain. A coat of asphalt will help hold the loose gravel in place.

Water from the roof must not be allowed to run down the walls of the house. A spout or canal projecting out away from the wall will solve the problem. A half section of split bamboo would do nicely, or, a trough made of wood or sheet metal would do as well. The spout should extend far enough away from the walls to prevent erosion - at least two feet.

*ARCH OF VAULT ROOFS* - (See Figure 88.) These types of roofs are used in areas where timber is scarce. They require some skill to build although in some areas such roofs have been used for centuries and local masons know how to build them.

Arched, vaulted or domed roofs are usually built of burnt brick although there is good reason to believe that well stabilized earth blocks can be used.

The outside walls of the house must be strong enough to resist the outward force caused by a vault or dome. In most cases walls are made very thick - 2 to 3 feet - depending on the distance between walls. In many cases rooms are placed side by side to help absorb the forces but the outside walls will still have to be very thick. A reinforced concrete bond beam around the top of the outside walls will add greatly to the strength and may make it possible to reduce the wall thickness. However, a qualified structural engineer should design any such walls and beams.

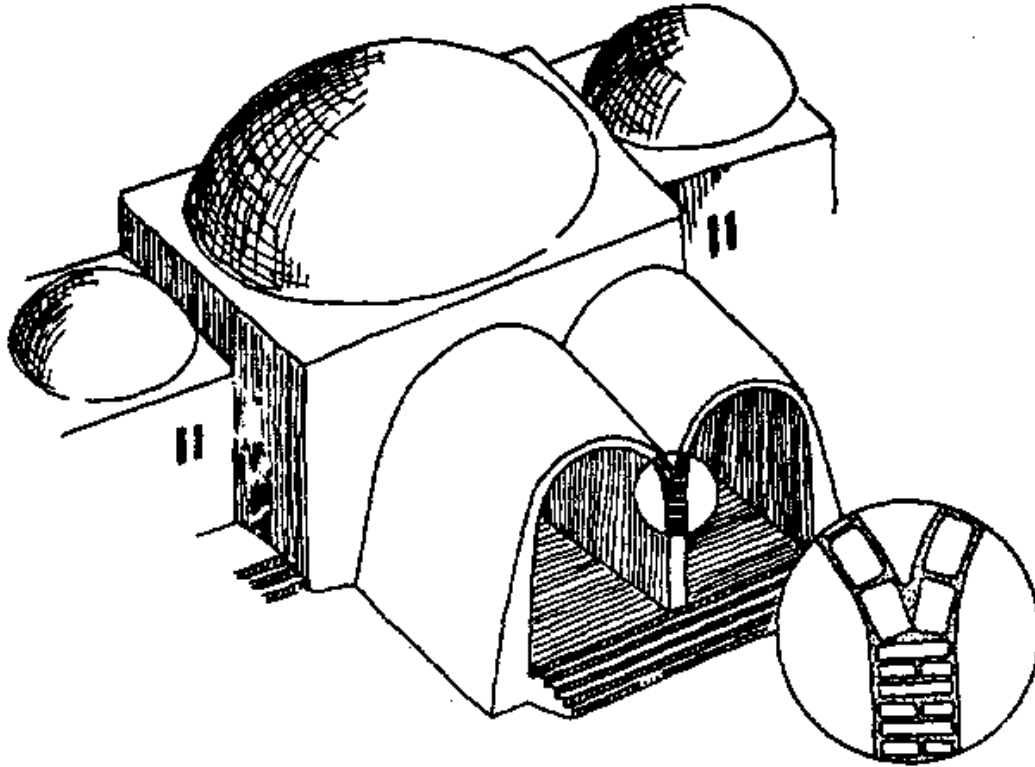

Figure 88. This style of earth dome and vault construction was used in a reconstruction program at New Gurna, Egypt.

The mortar used in laying brick or stabilizing earth block in an arch, vault or dome is usually of a quick-setting type. In many middle Eastern countries a mortar made with gypsum is common. If cement or lime mortar is used, it is necessary to have a form to support the brick until the mortar sets. This is usually too expensive and is rarely used in small house construction.

If you should use this type of roof, get methods and design from someone who has done it before.

*EARTH TILE ROOFS* - Earth tile have also been used for roofs. They can be pressed in a block making machine by using fillers. They can also be of sun-dried adobe but in either case it is best to stabilize the earth. The tiles are placed on a wooden frame just as shingles are. The tiles should be 1 1/2" to 2" thick and about 1' long. Good sun-dried tiles are made with a thatch (or grass) "tail." See Figure 89. The thatch tail helps prevent rain from eroding the block, and provides insulation for the inside of the house.

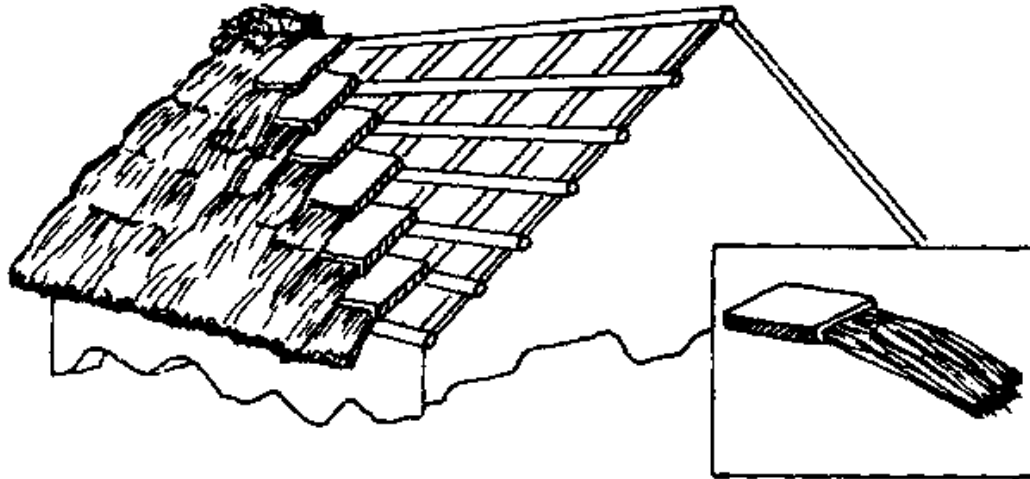

Figure 89. A thatched-earth tile roof of this design proved successful in research studies in India.

The best earth tiles are made with stabilized soil. Lime, cement and asphalt work well. Since they are so thin, tiles should have a very high resistance to the spray test.

The roof frame must be built strong enough to support the weight. Also, wooden strips (called stringers) must be placed in the roof at close enough intervals so that each tile rests on two stringers, either directly or indirectly. Tiles are often made with a lip or groove near the upper edge so that they will lie securely on the stringers.

## Chapter 13: Floors

The most desirable type of floors for an earth house is, of course, a concrete slab, a wood floor or a floor surfaced with cement tile or ceramic tile. However, in some areas where good sand and gravel are not available for concrete, and where wood is scarce and commercially made tile cannot be obtained, an earth floor can be substituted. Properly compacted earth or high strength stabilized earth tile will make a reasonably durable floor. Extra stabilizer is required if floors are to last a long time, because floors get the hardest wear of any part of the house. Even the most primitive dwellings have some type of oil or fat worked into the soil as a stabilizer.

*TYPE OF SOIL FOR EARTH FLOORS* - For earth floors, use the same soil you use to build your house but add extra stabilizer.

The floor must be able to withstand scrubbing and must be tough and durable.

Lime and portland cement make the best stabilizers. Emulsified asphalt will make good floors but the dark color may be objectionable. Wood ashes and even animal blood have been used.

*TAMPED OR RAMMED EARTH FLOORS* - Before making the earth floor, it is necessary to remove all organic topsoil, or at least down to 6 to 7 inches below the level of the finished floor. Then compact the top layer (3"-4") of existing soil with a tamper before the floor material is placed.

In areas where swelling soils are damaging to buildings this ramming should be avoided. Untamped soil will swell less than tamped soil.

The first layer above the existing soil is filled with about four inches of clean sandy or gravelly material. The



purpose of this material is to stop moisture that may rise up from the existing soil. The sandy material should be well tamped to strengthen it and to keep it from settling. If the existing soil is the swelling type, use about 6 inches of sandy material.

The floor is laid above the sandy course. Place it in two layers each about 1½ inches thick. The lower layer can contain less stabilizer than the top because it does not get any wear. The soil should be carefully rammed into place. Be sure the moisture content is correct. Check it using the method described in Chapter 2. When you finish tamping, level up the area by scraping or tamping high spots.

The final finished floor layer is placed next. This layer should contain enough stabilizer to make the cured surface difficult to scratch with a nail. This might require 2 to 3 times as much stabilizer as might be used in earth walls. Test your mix by making small rammed earth test blocks just as you would for a rammed earth wall. After the test blocks have cured check them for hardness and water resistance.

After tamping the top layer, smooth out any tamper marks and then cure the floor for several days.

Portland cement and lime-stabilized floors may be cured by sprinkling the floor or putting wet sacks on top of it. At the end of the curing period, a thin portland cement slurry made from cement, water and fine sand may be applied to the floor to seal any cracks and waterproof it. Certain oils will do the same job.

Don't walk on the floor until it is hard.

*TILE FLOORS* - Pressed earth tiles may do just as well as rammed earth floors. They can even look nicer, particularly if you make tiles from several different colored soils. The CINVA-Ram or any other block-making machine that makes; 1½ to 2" thick tiles can be used. Use enough stabilizer in the soil so the cured blocks are difficult to scratch with a nail. Make test tiles to check the stabilizer content.

Stabilized tiles should be moist-cured for 7 days and then dried in the sun before placing them. Prepare the floor area the same way you would for rammed earth floors. It is very important that the sandy layer be level and well-compacted before placing the tile. If it isn't, the floor will be rough and unsightly.

It is better to mortar tiles in place with a mortar of sand, portland cement and water. Carefully smooth the mortar joints to keep from having grooves in the finished floor. Tiles can be laid without any mortar if they are placed closely together. They may rock a little or come loose, but it won't hurt if they are put back right away.

Since cured tiles are used, the floor can be walked on as soon as the joints get hard. This will take 2-3 days. Oils or waxes may be used to seal the top surface of the floor. Tallow has been used, and if applied hot, beeswax may also be quite suitable.

*HEATING THE HOUSE THROUGH THE FLOOR* - You can heat your house by heating the floor.

This idea is used in the United States and other places in the world (Korea, for example) with tunnels under the floor. These tunnels carry heat from a fire which is built at one of the openings.

This method of heating should not be attempted unless you have someone experienced to show you how to do it.

## **Chapter 14: Surface coatings**

A surface coating is a layer or film of material placed over an earth wall.

This is what surface coatings do:

- (a) They can make some earth walls look better.
- (b) They can help earth walls shed rain water.
- (c) They can make earth walls last longer.

Decide whether you want to use surface coatings when you are planning your house - not after it is constructed.

*APPEARANCE* - Houses built of carefully made *pressed blocks* look better without surface coatings.

*Rammed earth* walls will have a pleasing appearance if the inside of the forms is smooth and in good condition during construction. In fact, some rammed earth house owners feel that a few form marks are pleasing to an earth wall and they do not care to use surface coatings. But if the insides of the forms were rough and in poor condition, a surface coating will probably improve the wall's appearance.

Most adobe home owners prefer surface coatings on their houses.

One way to decide on a surface coating is to look at other homes in your area. See if surface coatings helped their appearance.

Remember this:

A cheap or poorly applied surface coating that quickly peels off looks worse than none at all.

The owner must decide how often he is willing to repair the surface coating to keep it looking good. Most cheap surface coatings need repairing every 2 or 3 years. If the owner is young and healthy and does not mind the time and small expense of repairing the coating, a cheap surface coating may be suitable. But if the owner cannot perform frequent repair work, his walls will look bad, and they may suffer severe damage. Then a more expensive coating will be necessary.

*DAMAGE FROM RAIN WATER* - If you follow the instructions in Chapter 2 for selecting soils for earth houses, you won't have to worry about rain damage unless you have to use very clayey soils. If your test blocks, even when stabilized, do not pass the spray test, try a surface coating.

Even the most expensive surface coatings are likely to develop cracks and let some water through them and into the wall. If your wall contains a lot of clay, the water will cause it to swell and crack surface coatings that are stiff. Check to see whether this will happen to your surface coating. Completely coat a few test blocks of your soil mix and subject them to both the spray test and absorption test. If the surface coating cracks or peels, the same thing will happen to your house when coated.

*INCREASING THE LIFE OF THE WALL* - Other things beside rain may wear down an earth wall. Strong winds carrying dust, children throwing rocks or sticks, and even animals, can scar or damage earth walls - especially unstabilized ones. If these things occur in your neighborhood or area, then unstabilized walls should be coated. Most stabilized walls can resist them.

*COST OF SURFACE COATINGS* - Since most surface coatings require some type of stabilizer, you must decide whether it is best to use the stabilizer in the surface coating or in the wall itself. Surface coatings normally take less stabilizer than for stabilizing the entire walls. But it also takes additional time and money to apply surface coatings and keep them repaired. Unless you can get by with a thin, cheap surface coating, the total cost will be nearly the same whether you use a surface coating or stabilize the entire wall.

*TYPES OF SURFACE COATINGS* - There are four main types of surface coatings:

- (a) Plasters
- (b) Slurries
- (c) Paints
- (d) Special chemicals

*Plasters* are placed on the walls in fairly thick layers - about  $\frac{1}{2}$ ". Below is a high-quality plaster mix that has worked well on earth houses:

1 part portland cement

4 to 5 parts clean sand

Sufficient water to make a thick mixture

Add a small amount of lime if the plaster is hard to spread.

Apply this plaster in two coats, each about  $\frac{1}{4}$ " thick. Moisten the wall and then throw or "splatter" the first coat against the wall with a large brush. This will not only bond the plaster to the wall, it will leave it rough so the second coat will bond to it. (See page 143 concerning reinforcement of plasters.) Cure this coat at least 12 hours (more in wet areas) before applying the second coat. The second coat may be brushed on also, but if a smooth surface is desired, put it on with a metal trowel. Rough surfaces have less tendency to crack and they look better on most homes.

Don't apply cement plasters on a sunny wall; wait until it is shaded. When a section of wall is completed, cover it and keep it moist for a day or two, until it gains strength.

Cement plasters should be used only on stable walls. Remember that walls containing a lot of clay will swell and crack the coating.

Low-cost mud plasters can be made by combining a soil mix with water. These are called Dagga plasters. Dagga plasters made with the right kind of clay and having sufficient sand in them may be as good as any other plasters. Most good ones contain about 2 parts sand to one part clay. Dagga plasters will not last if they contain too much clay, the wrong kind of clay, or when they are too soft. The red and brown laterite clays found in the tropic zones make excellent Dagga plasters.

Dagga plasters can be improved by adding a stabilizer to them. Lime or cement work well. Try one part lime or cement to 9 parts of soil. Asphalts can also be used in Dagga plasters to waterproof them but they will not harden the plaster and they may make it too dark to look good on a house. Many of the other stabilizers mentioned in

Chapter 3 can be used. Experiment by trying them out on small sections of your wall or on test blocks of your soil mix. Watch for damaging cracks as the plaster dries.

Dagga plasters are usually applied to a previously moistened wall with a trowel to a thickness of about ½". Roughening the dagga surface will help to keep cracks from forming when the plaster dries.

*Slurries* are mixtures of cement or lime and water. They are brushed on the wall in thin coats like paint. Good ones may last 5 to 10 years.

Some of the best slurries are made from equal parts of cement and lime mixed with enough water to make a thick liquid. Adding a small amount of clean, fine sand will give the slurry a gritty texture.

Moisten the earth wall before the slurry is applied. Then brush on two coats at intervals of 24 hours. Keep the slurry mixed while applying it or some of the materials may settle to the bottom of the container.

Slurries make economical surface coatings, but they must be applied to the right kind of wall. Earth walls that shrink and swell will cause them to crack and peel off.

Paints make good surface coatings for some walls. Cement-based masonry paints work best. They are tougher and last longer than plain cement slurries. Present oil-based house paints and aluminum paints do not work on earth walls. However, new ones may be developed that work as well as cement-based paints.

It is not practical to include a list of manufactured paints that have worked on earth walls because they may not be available in your area. If you want to try them, see the nearest paint salesman. Ask him for a demonstration and samples of his paints. Then see how they work on test blocks of your soil mix. Perform the spray test on completely painted test blocks and if you have enough time, allow the blocks to weather outside. The performance of these test blocks should tell you how well the paint will work.

You can make a cement-based paint but it takes several chemicals. Here is one that has been used:

1 part calcium stearate (powdered).

2 parts calcium chloride (powdered).

50 parts portland cement.

25 parts clean, fine sand.

Mix these ingredients together to obtain a uniform mixture. Then add 50 parts water and mix with a hoe until a creamy mixture is obtained.

Pour the mixture through a fly screen to remove lumps and large particles.

Use white portland cement in the mixture if a white coating is desired. For other colors, add 3-4 parts of a powdered, oxide pigment.

Apply the paint in two coats with a large brush. Moisten the earth wall before applying the first coat. Paint only on shady walls and keep the painted surface slightly moistened so the cement does not cure too quickly. The second coat should not be applied sooner than 12 hours after the first.

Only the second coat needs to be colored. It can also be thrown on the surface with a large brush or broom to.

obtain a pleasing surface texture.

White-wash paints - or water mixed with lime - can improve the appearance of earth walls. But they offer little, if any, protection against water or wear, and they only last for a short time. However, they are not costly and they are easily applied with a large brush.

A whitewash which offers some protection against water can be made with the following materials:

1½ gallons unslaked lime.

3½ gallons of water.

½ pound of melted tallow.

Boil the water in a large can, add the lime, and stir well. Then add the melted tallow to the boiling mixture and stir again.

Apply the mixture with a large brush. Add a little water if it is difficult to spread.

This white-wash will last about a year in most climates.

Certain *chemicals*, applied similar to paints, will make good surface coatings. One mentioned in Chapter 3 is a mixture of 1 part sodium silicate (40° Baume) and 3 parts water. The solution is brushed into the wall with a fairly stiff brush to get good penetration. Apply two coats a few minutes apart. A suitable wetting agent or surfactant (see Chapter 3) added to the solution will increase the penetration of the treatment in some walls.

The only way to find out whether chemicals will work is to try them. Spray tests and weathering tests should be performed on treated test blocks of your soil.

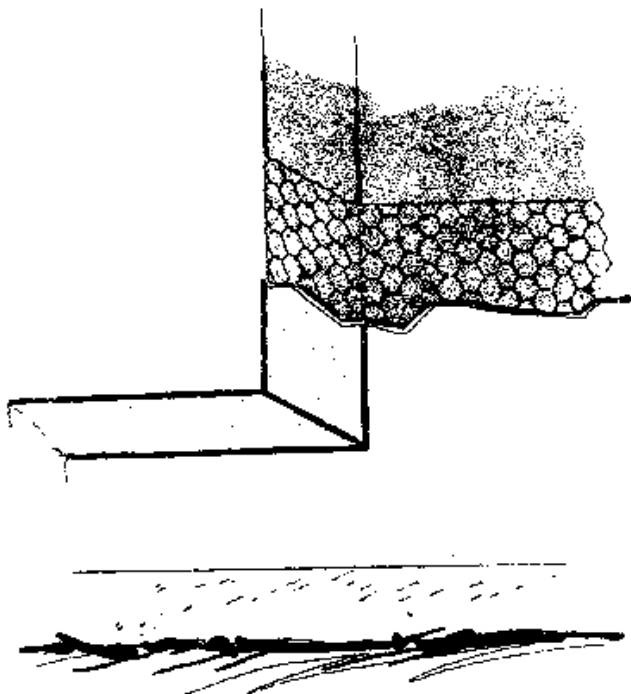

Figure 92.

*PREPARING THE SURFACE* - Surface coatings applied to poorly prepared walls will soon peel off. Before applying any surface coating, the entire thickness of wall must be completely dry. For properly cured blocks, this may take only a few weeks until the mortar dries. Rammed earth, wattle and daub, and cob walls will take much longer. In rainy area', walls may be damaged before they get dry enough to apply surface coatings. If this is liable to happen to your wall, use the stabilizer in the wall so it will be protected from the time of construction.

When completely dried, the wall must be brushed or swept to remove dust and other loose particles. Just before slurries or plasters are applied to a wall, moisten it slightly. Painting

the wall with a thin mixture of portland cement and water improves the bond between the wall and surface coating.

*REINFORCEMENT* - To strengthen plasters and improve their bond to the earth wall, wire reinforcement should be used. Woven wire fencing works well. Fasten the wire securely to the top of the earth wall by placing it in the last mortar joint or between the bond beam and the top of the earth wall. For houses with bunker fill roofs, the wire should be attached near the roof fill, brought over the top row of blocks, and bent down along the wall. This method is shown in Figure 65.

The reinforcement should extend into window and door openings so the plaster will be reinforced at all points. (Figure 92.) Nail it to the wall every 6-8 inches. Special nails with roughened surfaces work best.

When two coats of plaster are used, the first coat should be thrown or spattered through the wire reinforcement. This improves the bond between wall and plaster and also leaves the reinforcement approximately midway in the plaster coat.

When wire reinforcing is not available, the bond to the earth wall can be improved by leaving a deep opening in the vertical mortar joints. Chips of broken rock or concrete, inserted into wet mortar, will also bond thick surface coatings to the wall. (See page 102 for discussion of these methods.) For rammed earth walls, cut shallow holes 6 to 8 inches apart and drive nails in these holes until their heads are even with the outside wall surface. Another way is to cut long, narrow grooves 6 to 8 inches apart in the wall.

Remember that the strongest plasters are reinforced with wire. Use it if you can.

## **Suggested references**

Many good books are available that cover special subjects on earth houses in greater detail than can be done in this short manual. The ones listed below are some of the best ones available.

1. *ASTM Standards 1958, Part IV*. American Society for Testing Materials, 1916 Race St., Philadelphia 3, Pennsylvania.
2. Burkhart, Edsel J. *Investigation of Soils and Building Techniques for Rammed Earth Construction*, A. & M. College of Texas, Texas Engineering Experiment Station Research Report No. G. College Station, Texas, May, 1949. (Out of print.)
3. Cytryn, S. *Soil Construction*, State of Israel, Ministry of Labor, Housing Division, The Weizmann Science Press of Israel, Jerusalem, 1957.
4. *Earth for Homes*. Ideas and Methods Exchange No. 22, Housing and Home Finance Agency, Washington 25,

D. C., March, 1955.

5. Fitzmaurice, Robert. *Manual on Stabilized Soil Construction for Housing*. Technical Assistance Program, United Nations, Sales No. 58.II.H.4, New York, 1958.

6. Harrington, E. L. *Adobe as a Construction Material in Texas*, A. 8: M. College of Texas, Texas Engineering Experiment Station Bulletin No. 90, College Station, Texas, 1945. (Out of print.)

7. *Housing and Town and Country Planning*. United Nations Bulletin No. 4, Sales No. 1950.IV.6, New York, October, 1950.

8. Long, J. D. *Adobe Construction*, University of California, Agricultural Experiment Station Bulletin No. 472, Davis, California, revised November, 194:6.

9. *Low Cost Houses*. Building Research Unit Bulletin No. 1, Council of Scientific and Industrial Research, Roorkee, U. P., India, September, 1949.

10. *Methods of Tests for Soil Classification and Compaction*. British Standards Institute, British Standard 1377, British Standards House, 2 Park Street, London, W.1, 1948.

11. Middleton, G. F. *Earth Wall Construction*, Commonwealth Experiment Building Station Bulletin No. 5, Sidney, Australia, 1952.

12. Webb, T. L., Cilliers, T. F., and Stutterheim, N. *The Properties of Compacted Soil and Soil Cement Mixtures for Use in Building*, National Building Research Institute, Union of South Africa, Pretoria, Series DR2, March, 1950.

13. Wolfskill, L. A., Dunlap, W. A., and Gallaway, B. M. "Earth Home Construction, a Field and Library Compilation with an Annotated Bibliography," Texas Transportation Institute, College Station, Texas, Bulletin No. !8, March, 1962.

## **Appendix A - Atterberg Limits of Soils**

The Atterberg limit tests on soils are simple tests that will tell you very generally whether the soils contain much clay and whether this clay will be harmful in your soils. There are two tests that you must perform: the liquid limit and the plastic limit. From these you can get a value called plasticity index. (The bar shrinkage test can also be used to get the plasticity index.)

These tests require some special equipment and a little bit of experience. You can do them yourself if you are careful, but it is better to have someone who knows how to do them.

The general equipment you will need to do these tests is listed below. Special items needed for each test are listed with that test procedure.

### *General Equipment Needed*

1. *Dish* - A smooth-bottomed round dish about 4½ inches in diameter and 1½ inches high. It is best if the inside is smooth or glazed. The type which chemists call evaporating dishes can be used.

2. *Spatula* - A spatula (or pill knife) has a flexible blade about 4 inches long and  $\frac{3}{4}$  inches wide.
3. *Balance* - A balance or scale that will weigh at least 100 grams and is accurate to at least 0.1 grams. (An accuracy of 0.01 grams is better.)
4. *Oven* - A drying oven that will keep a temperature of 110°C or 230°F. This temperature is a little higher than the temperature at which water boils. The oven should have vents in it so the heated air will circulate.
5. *Boxes* - A few lightweight metal containers with tight fitting covers. Small aluminum or tin pill boxes work well. Curved pieces of thin glass like that used on large pocket watches or clocks can be used. They should be about 2 or 2½ inches across.
6. *Sieve* - A No. 40 mesh U. S. Bureau of Standards sieve or a No. 36 mesh British Standards sieve. You can do without a sieve, but it is better to have one.
7. *Forms* - Write the information you get from the test on a form of your own design.

### *Sample*

You will need a sample weighing about 100 grams (a small handful) taken from the soil that you want to test. All of this sample should pass a No. 40 mesh (or a No. 36 British Standard) sieve. This sieve has openings about 1/64 inch square. If you do not have one, you can pick all grains larger than 1/64 inch out of the sample by hand. It will be easiest to do this if the sample is first dried in the sun and crushed up.

If you already know that you are going to add a stabilizer to your soil, then add the same proportion of stabilizer to your sample as you intend to use in your house.

### *A. Liquid Limit Test*

#### *Special Equipment*

For this test you will need a special tool to cut a groove in the soil. The grooving tool is carefully made so it cuts a groove exactly 2 millimeters wide with the sides of the groove sloping at an angle of 60° to the horizontal. If you cannot get one of these grooving tools, it is possible to use a spatula or even a knife.

#### *Procedure*

1. Place about three-quarters of your soil sample in the dish. Add small amounts of water to it, and thoroughly mix the water and soil. The water that you use should be of good quality, such as water you might drink. Add water until the mixture is a thick paste. Be sure that it is mixed well so it has no dry or wet spots.
2. Shape the soil mixture in the dish into a smooth layer 1 centimeter (approximately 3/8 inches) in thickness at the center of the dish. Divide the mixture into 2 equal portions by drawing the grooving tool down the center of the mixture. The point of the grooving tool should be placed against the bottom of the dish. Pull it through the soil so that it always stays at right angles (perpendicular) to the dish, leaving a V-shaped groove with a flat bottom that is 2 mm wide. Very sandy soils may be torn by this method. If so, cut the groove in several passes, making each pass go deeper until the clean surface of the dish shows at the bottom of the groove. If you do not have one of the grooving tools, carefully cut a groove in the soil using a knife or spatula. Make the bottom of the groove 2 mm wide and make sure that the sides slope up at an angle of 60° with the horizontal.



3. Hold the dish firmly in one hand with the groove in the soil pointing directly in front of you. Then tap the dish lightly with a horizontal motion against the heel of the other hand 10 times. The dish should be moved a distance of about 1 to 1½ inches to strike it against the other hand which should remain still. If the amount of water is just right, the groove will flow together at the bottom for a distance of exactly ½ inch. When it takes more than 10 taps to make the groove flow together, the soil is too dry. Add a little water. If it flows together with less than 10 taps, it is too wet. The soil can be dried by mixing it a while, or by adding some dry soil.

4. When the moisture in the soil has been adjusted so that the groove closes for ½ inch after 10 taps, the soil is at the liquid limit. With your spatula scrape a sample of the soil out of the dish at the point where the groove closed. Use a large sample if your balance is accurate only to 0.1 grams. Put this sample in one of your containers and quickly weigh the container and soil before the water evaporates. If your containers have lids, put them on to keep the water from evaporating during weighing.

5. Write the weight of the container and soil opposite  $W_1$  on your form. Then put the soil container in the 110°C oven until all the soil is dry. This should take 8-10 hours, but may be less. You can check by weighing it several times. When the weight no longer changes, it is dry. Now write the weight of the container and dry soil opposite  $W_2$  on the form. The weight of the clean dry container,  $W_c$ , must be known also.

### *Calculations*

The liquid limit is calculated as follows:

$$\text{Liquid limit} = \frac{\text{weight of water}}{\text{weight of oven-dried soil}} \times 100$$

or

$$\frac{W_1 - W_2}{W_2 - W_c} \times 100$$

### *Precautions*

1. Be sure to use only material passing the No. 40 mesh sieve (or smaller than 1/64 inch) for the liquid limit test.
2. To get the best test results, thoroughly mix the soil and water. Tap the dish against the hand the same way with all types of soils.
3. Do not vibrate or jar the dish after the soil is grooved and before it is tapped.
4. After the groove has been closed, take the soil sample and weigh it quickly to prevent further loss of moisture.

### *B. Plastic Limit Test*

#### *Special Equipment*

The only special item you will need for this test is a surface to roll a soil sample on. A glass plate or a piece of smooth, shiny paper will work well.

### *Procedure*

1. Take some of your dry soil sample and add water to it. Mix it thoroughly by squeezing and kneading it with the fingers and palms of the hands. The moisture content is about right when the soil can be easily shaped into a ball without sticking to the fingers.

2. Shape the soil mixture into a roll between the palms of your hands until it is about 2 inches long and ¼ inch in diameter. Then put this roll on a glass plate or piece of paper. Using the palm or fingers of one hand roll it into a thread. If the sample sticks to the plate or paper, it is too wet and must be dried some more.

Apply just enough pressure with your hands to cause the thread to get gradually smaller until it reaches 1/8 inch in diameter. You are looking for the thread to break or crumble just when it reaches 1/8 inch in diameter. If the thread breaks before it reaches 1/8 inch diameter, it is too dry. Thoroughly mix in some water and try again. If it can be rolled smaller than 1/8 inch diameter, just roll it up into a large thread and start over again. It will dry gradually by rolling it out. When it is just right, the 1/8 inch threads under your hands will crack or crumble into pieces about ½ inch long.

3. Collect the broken or crumbled soil threads and place them in one of your containers. Weigh the soil and container. Call this weight W1 and record it. Then dry the soil in the 110°C oven until all the water is driven off. Weigh the dry soil and container and record this weight as W2. The weight of the clean dry container, Wc, must also be known.

### *Calculations*

The plastic limit is calculated as follows:

$$\begin{aligned}\text{Plastic limit} &= \frac{\text{weight of water}}{\text{weight of oven-dried soil}} \times 100 \\ &= \frac{W_1 - W_2}{W_2 - W_c} \times 100\end{aligned}$$

### *C. Plasticity Index*

Get the plasticity index of the soil by subtracting the plastic limit value from the liquid limit. It is calculated as follows:

$$\text{Plasticity index} = \text{Liquid limit} - \text{Plastic limit}$$

### *D. Bar Shrinkage Test*

The bar shrinkage test is an easy way to find the plasticity index of a soil. It will also give you some other very good information about your soil. It has one advantage: you won't need a balance to do weighing. But, you will

need a special piece of equipment.

### *Special Equipment*

For this test you will need a special metal mold shaped like a box but without a top. The best size is 5 inches long and  $\frac{3}{4}$  inches by  $\frac{3}{4}$  inches square.

### *Procedure*

1. The sample you use for this test should be prepared exactly like the one for the liquid limit test. It should be mixed with enough water to make it slightly more fluid than the liquid limit. For example, cut a V-shaped groove in the soil as explained in Step 2 of the liquid limit procedure. If the groove closed with about 5 taps of the dish against the heel of the hand, the mixture is just right.
2. Place a very thin coating of grease or vaseline on the inside walls of the shrinkage mold. This will keep the soil from sticking to the mold as it dries. Place enough wet soil to fill the mold one-third full. Gently jar the mold or tap it on a stack of papers to cause the soil to flow into a smooth layer. This will also remove unwanted air bubbles in the soil. Put in more soil and jar the layers until the mold is completely filled. Scrape the excess soil from the top of the mold with a straight stick or piece of metal.
3. Dry the soil bar. To keep it from cracking, first let it dry at room temperature for one day. Then put it in the 110°C oven until it dries completely. Very accurately measure the length of dried soil bar. Also measure the exact length of the mold in case it is not exactly 5 inches long.

### *Calculations*

The bar shrinkage is calculated as follows:

$$\text{Bar shrinkage} = \frac{(\text{Length of wet bar}) - (\text{length of dried bar})}{\text{Length of wet bar}} \times 100$$

### **Test for Strength of Foundation Soil (Clays)**

How strong is the foundation soil? How wide and how thick should the footing of portland cement concrete be?

To get the answers to these questions we must first get some measure of the strength of the foundation soil at the site where the house is to be built.

You should dig several small pits like the one in the picture (see Figure 93) and from each one, cut a small block of soil and trim it with a knife so that it will be just the same size as shown. Take the small blocks and test them in the lever tester shown in Figure 94 which you can make for this purpose. Push at Point A first with your first finger. If the soil block crushes, the foundation soil is very soft and a large house should not be built on it. If the soil does not crush when you push at A, it has some strength and the test should be continued. Now push at B. If you can crush it by pushing with one finger at B you know that the strength of the soil is greater than the one that failed from pressure at A so you will look in Table 4 in the column marked A and opposite the type of house you

plan to build to read the width and thickness of the continuous concrete wall footing. If you cannot crush it by pushing at B, then try at C. If the soil crushes at C, then use the width and depth of footing opposite B in the table and so on. You may find some clays that will not crush when you push on the end of the lever. These are very strong soils and you may use the sizes shown in the table at E. You should be able to push with one finger as shown in the picture, 18 to 20 pounds (8 to 9 Kg.). See how much you can push by pushing on a set of scales or balances. If you push only 10 to 12 pounds then use the footing size next larger than you would otherwise.

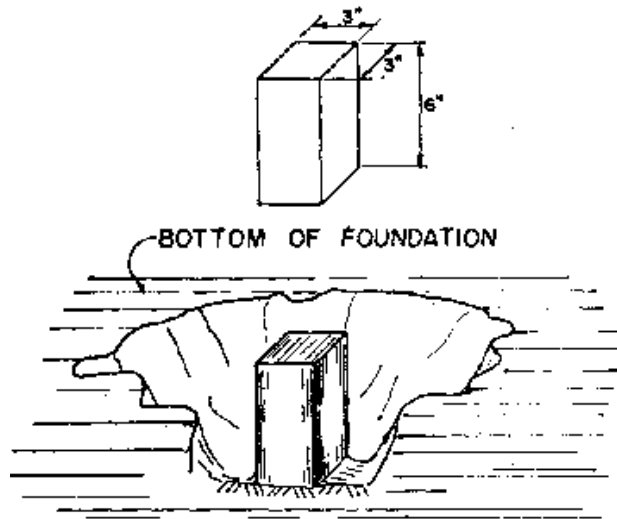

**CUT FOUNDATION SOIL**  
**TEST SAMPLE LIKE THIS AND**  
**TRIM BOTTOM AND TOP SQUARE**

Figure 93.

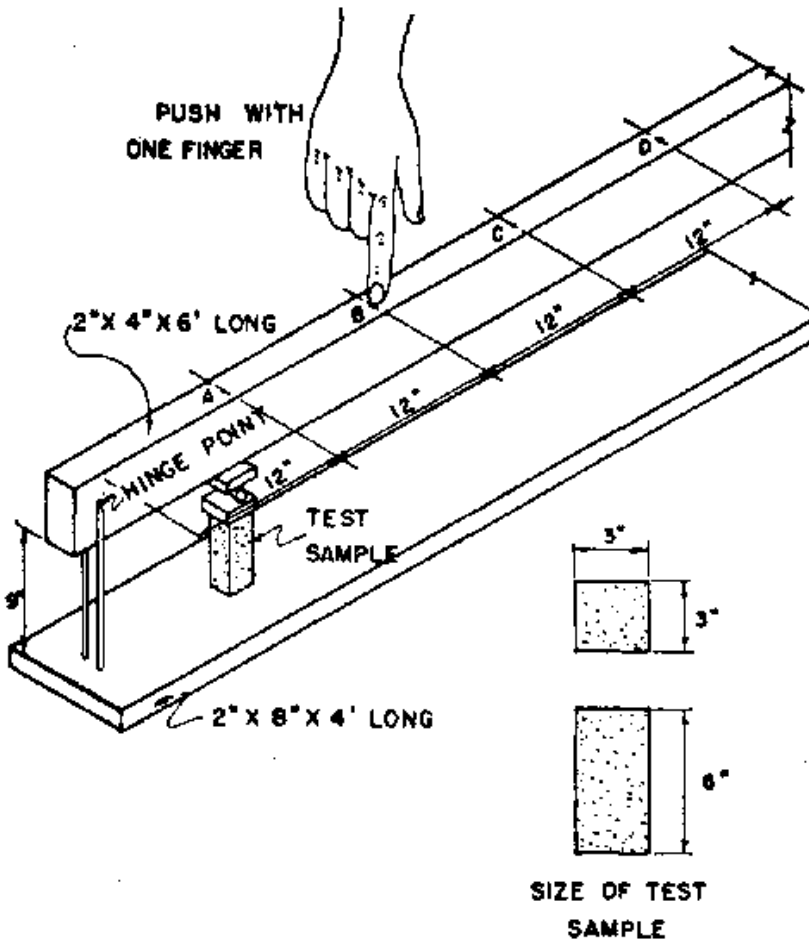

Figure 94. Simple lever tester for soils.

## Appendix B - Useful Formulas

Area of circle ( $p = 3.14$ ,  $r = \text{radius}$ )

$(p) (r^2)$ .

Area of triangle ( $h = \text{height}$ ,  $b = \text{base}$ )

$\frac{1}{2} (b) (h)$ .

Area of rectangle ( $a, b = \text{length of sides}$ )

$(a) (b)$ .

Volume of block ( $a, b, c = \text{lengths of sides}$ )

$(a) (b) (c)$ .

Unit weight of block

(a,b,c = length of sides in inches) (W = weight in pounds)

$$\frac{(W) (1728)}{(a) (b) (c)}$$

Volume of cylinder (h = height)

$$(p) (r^2) (h).$$

Unit weight of cylinder (r = radius in inches)

(h = height in inches)

(W = weight in pounds)

$$\frac{(W) (1728)}{(\pi) (r^2) (h)}$$

Compressive strength

(P = failure load)

(A = cross sectional area of specimens)

$$\frac{P}{A}$$

Moisture content, w

(W1 = wet weight of soil)

(W2 = dry weight of soil)

$$\frac{W_1 - W_2}{W_2}$$

Plasticity index,

P.I. (L.L. = liquid limit) (P.L. = plastic limit)

**L.L. - P.L.**

Examples of Long Multiplication

a.)

19 x 328

328

\_19

2952

328

6232

b.)

19 x 32.8

32.8

\_19

2952

328

623.2

c.)

1.9 x 32.8

32.8

\_1.9

2952

328

62.32

d.)

23.7 x 41.8

41.8

23.7

2926

1254

836 \_\_

990.66

Examples of Long Division

a.)

328

19

17.26\_

19/328.00

19

138

133

\_\_\_\_50

\_\_\_\_38

\_\_\_\_120

\_\_\_\_114

\_\_\_\_6

b.)

\_32.8

\_19

\_\_1.73\_

19/32.80

\_\_19

\_\_138

\_\_133

\_\_\_\_50

\_\_\_\_38

\_\_\_\_12

c.)

\_32.8



\_\_1.9

\_\_\_17.26\_

1.9/32.800

\_\_19

\_\_138

\_\_133

\_\_\_50

\_\_\_38

\_\_\_120

\_\_\_114

\_\_\_6

d.)

\_\_41.8

\_\_23.7

\_\_\_1.76

23.7/41.800

\_\_23.7

\_\_18.10

\_\_16.59

\_\_\_1.510

\_\_\_1.482

\_\_\_28

### **Conversion of Weights and Measures**

#### **LENGTH**

*Metric*

***English***

1 meter

1.094 yard

1 meter

3.281 feet

1 meter

39.37 inches

0.914 meter

1 yard

0.305 meter

1 foot

1 centimeter

0.394 inch

2.540 centimeters

1 inch

**AREA**

1 square centimeter

0.155 square inch

6.452 square centimeters

1 square inch

1 square meter

10.764 square feet

0.093 square meter

1 square foot

## **VOLUME**

1 cubic centimeter

0.061 cubic inch

16387 cubic centimeters

1 cubic inch

1 cubic meter

35.314 cubic feet

0.028 cubic meter

1 cubic foot

3.785 liters

1 gallon (British)

1 liter

0.264 gallon

1 liter

1.057 quarts

0.946 liter

1 quart

## **WEIGHT**

1 kilogram

2.205 pound'

0.454 kilogram

1 pound

1 gram

0.0353 ounce (av)

28.349 grams

1 ounce (av)

***English***

1 foot

12 inches

0.0833 foot

1 inch

1 yard

36 inches, 3 feet

1 square foot

144 square inches

1 square yard

9 square feet

1 cubic foot

1728 cubic inches

1 cubic yard

27 cubic feet

1 cubic foot

7.481 gallons

1 gallon

0.1337 cubic foot

1 pound

16 ounces

1 ton (short)

2000 pounds

***Metric***

1 meter

100 centimeters, 1000 millimeter

1 square meter

10,000 square centimeter

1 cubic meter

100,000 cubic centimeters

1 kilogram

1000 grams

## **Glossary**

1. *Absorption* - The taking in of water or other liquid into a soil mass.
2. *Adobe* - Any kind of clay soil which, when mixed with water to a plastic consistency (sometimes with a mechanical binder), can be made into a part of a structure. A structure, usually, a building block, made of such clay.
3. *Angle* - The figure formed by the intersection at a point of two lines. A right angle is such a figure in which the lines intersect at an angle of 90°.
4. *Azaras* - Split palm trunks used as earth mix reinforcement in the construction of floors and flat or domed roofs in the arid zones of west Africa. Azaras are approximately 8 feet long.
5. *Bauge* - A mixture consisting of clay soil and straw, used for building earth walls between forms (French).
6. *Batter Boards* - Light planks of wood nailed in a horizontal position to ground stakes. They are used to fix string lines which locate the boundaries of excavation or building.
7. *Bond* - A connection made by overlapping adjacent parts of a structure such as bricks. Also to hold together or solidify as a binder.
8. *Bond beam* - A horizontal beam, usually of concrete or wood, placed at the top of a wall to reinforce the wall. The bond beam helped to distribute the load of the rafters of the roof to the walls.
9. *Cajon* - A type of earth wall construction in which a clay soil mix of appropriate consistency is used in the form of wall panels supported by a structural wall frame. (Spanish.)
10. *Capillary rise* - The vertical rise of water in a fine grain soil due to natural forces within the small pore spaces.
11. *Clay* - The smallest grain size division of soils composed principally of flat particles smaller than 0.002 millimeters.
12. *Cob* - Walls built of a fairly stiff mixture of clay soil, water and small quantities of straw or other suitable mechanical binders. This mix is applied in consecutive layers without the use of shuttering. The walls faces are

pared down as the work proceeds. Cob walls have also been built of a mixture of crushed chalk and water.

13. *Cohesion* - The ability of two particles to stick together.

14. *Compaction* - The closer packing of soil particles by mechanical means to obtain a denser mass.

15. *Curing* - A time period in which the action of water in a stabilized soil mass causes the mass to be cemented together by the stabilizer.

16. *Dagga plaster* - A mixture of clay and sand used as a plaster to protect the walls and also as a mortar in laying up earth blocks. Often stabilizing admixtures are added.

17. *Durability* - The resistance of a material to wearing down.

18. *Emulsified asphalt* - A mixture of finely divided asphalt suspended in water and used in liquid form as a stabilizing agent in earth blocks.

19. *Fly ash* - The smallest size particle of slag or clinker; a product of the burning of coal or lignite.

20. *Foundation* - The lowest structural part of a building that connects the walls to the ground.

21. *Hydrometer* - A scientific device which, floating in a liquid, is calibrated to determine the specific gravity of the liquid.

22. *Impenetrable* - The ability of a soil material to restrict the flow or seepage of water to a negligible amount.

23. *Laterite, lateritic* - Clay soils formed under tropical climate conditions by the weathering of igneous rock. They consist chiefly of stable clays and hydroxides of iron and aluminum.

24. *Lintel* - A small beam that is used to span across a window opening to support the wall above the opening.

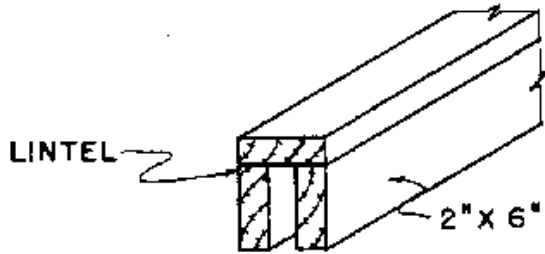

USE 3 PIECES - 2" X 6" X 4'-4" OVER  
3-FOOT OPENINGS IN 6" AND 9" WALLS.

USE 4 PIECES OF THIS SIZE OVER 3  
FOOT OPENINGS IN 12" AND 15" WALLS.

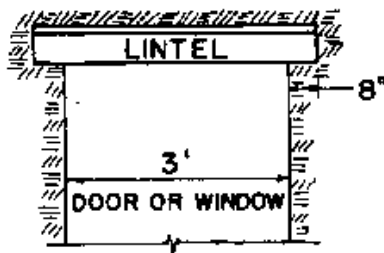

Figure 95. Wood lintel.

25. *Liquid limits* - That moisture content in percent of dry soil weight at which the soil changes from a plastic to a liquid state.

26. *Mechanical analysis* - The determination of the grain size distribution of a soil material. Also known as a sieve analysis.

27. *Moisture content* - The amount of water contained in a soil material expressed as the weight of the water divided by the weight of the dry soil material in percent.

28. *Mortar* - A plastic mix of sand, cement and possible clay which is used to bond together building blocks.

29. *Nogging* - Rough earth, brick, or concrete masonry used to fill in the open spaces of a structural frame.

30. *Optimum moisture content* - The moisture content for a soil mix in which, for a given compactive effort; the densest specimen is obtained.

31. *Osiers* - A forte of wattle made of willow branches and dry wood rods which are woven into a basket like frame to receive a plaster of plastic earth.

32. *Pallet* - A small flat board that is used to carry a freshly made building block.

33. *Parallel* - The idea of two lines or planes that always remain an equal distance apart. As a result, they never cross.

34. *Permeable* - The passage of water or other liquid through a soil mass.
35. *Perpendicular* - The intersection of two lines so that a right angle or 90° angle is formed between the lines.
36. *Pise-de-terre* - The French term for rammed earth.
37. *Pitch* - The angle or slope of a roof, usually expressed as a ratio of the vertical rise to the horizontal distance such as a pitch of one to three. This would mean that for every three feet of horizontal distance, the roof would rise one foot.
38. *Plastic limit* - That moisture content in percent of dry soil weight at which the soil changes from a solid to a plastic state.
39. *Plasticity* - The ability of a moist soil to be deformed and hold its shape. This indicates that the soil has cohesion and contains clay particles,
40. *Plasticity index* - The numerical difference-between the liquid limit and the plastic limit.
41. *Plating* - A technique combining stabilized earth with common rammed earth by placing a thin cement stabilized soil mix against the outward side of the form work (forming the exterior wall face), the remainder being compacted with an ordinary unstabilized soil mix. Plating techniques may also be used in the manufacture of earth blocks.
42. *Poured adobe* - A mixture of clay, soil, and water, of a fairly moist consistency enabling it to be cast between form work and then left to dry. The process of casting may either be carried out in one operation to full wall height, or in successive operations by means of "climbing" form work. Rocks are often embedded in the earth.
43. *Pozzolan* - A mixture of fine particles which, though not a cement in itself, will combine with lime to form a cement.
44. *Puddled mix* - A mixture of soil with enough water so that a plastic mix which easily flows is formed. This is distinguished between a moist mix which has just enough water to lubricate the particles.
45. *Rammed earth* - A mixture of sandy clay soil and water, of a slightly moist consistency enabling it to be compacted between shuttering form monolithic walls or in molds for making individual blocks. Ramming may be carried out by either hand or machine tamping.
46. *Rectangle* - A four sided figure whose opposite sides are parallel. All four corners are right angles. Opposite sides are equal but adjacent side are not necessarily equal.
47. *Reinforcement* - A very strong material, usually steel rod or wire. placed in compacted soil to increase the strength of the structure.
48. *Sampling* - The obtaining by digging or boring of a representative amount of a natural soil in place. Also the separation of a small quantity of representative material from a larger quantity of loose soil material.
49. *Sand* - The smallest sized portion of the coarse soil materials. It is that portion of a soil material which passes the U. S. Standard Sieve No. 10 but is retained on the U. S. Sieve No. 200.
50. *Shrinkage* - The decrease in volume of a soil material caused by evaporation of water.



51. *Shrinkage Limit* - That moisture content expressed in percent of dry soil weight below which a change in moisture content causes no change in volume of the soil mass.
52. *Silt* - The larger sized portion of the fine grain soil particle usually defined as the material passing a U. S. Standard No. 200 Sieve down to the minimum size of .005 millimeters.
53. *Slurry* - A mixture with soil with enough water to make a very soupy liquid that will easily pour.
54. *Sod locust* - Houses with walls and perhaps roofs constructed of close matted sod cut into blocks. Usually laid in the wall with grassy side down. Used extensively in early days of the development of the Great Plains area of the United States of America.
55. *Specific Crudity* - The ratio of the unit weight of a given material to the unit weight of water.
56. *Stabilization* - The Improvement of soil properties by the addition of proven materials which will either cement the soils, water proof the soil, or reduce volume changes.
57. *Stabilizer* - A material such as portland cement, lime, asphalt and many chemicals which will stabilize a soil material.
58. *Strength* - The ability of a material to resist applied forces. The strength of soil mixes is normally considered the strength in shear stress and is expressed in pounds per square or kilograms per square centimeter.
59. *Studding* - Structural members such as wooden planks or poles which are set vertically in a wall to support the weight of the roof.
60. *Tapia* - A form of adobe used in parts of Africa and Trinidad using a strong fibrous grass, often *sporobolus indicus*, cut into short lengths as a mechanical binder.
61. *Teroni* - A form of construction similar to adobe brick and "soddys" in its application in which a sod block is cut in its natural bed in marsh land. and, after sun curing, is laid up on a wall.
62. *Torchis* - A mixture consisting of clay soil and cow hair, used for building daub walls. (French.)
63. *Tubali* - A West African term for hand made, pear shaped "bricks" made from a mix consisting of clay soil, water, and short pieces of fresh or dried grass. Tubalis are laid with their wide base downward in a bed of mortar, three, four or more abreast, Consecutive courses are placed with their bases interlocking between the pointed top of the lower course. Tubali walls are built with a taper.
64. *Vigas* - Poles used as rafters for earth roof construction.
65. *Wattle and daub* - A woven frame of small branches which is smeared or daubed with plastic earth, the operation being continued until all construction cracks are filled.

Since 1961 when the Peace Corps was created, more than 80,000 U.S. citizens have served as Volunteers in developing countries, living and working among the people of the Third World as colleagues and co-workers, Today 6 000 PCVs are involved in programs designed to help strengthen local capacity to address such fundamental concerns as food production, water supply, energy development, nutrition and health education and reforestation.

Peace Corps overseas offices:

BELIZE

P. O. Box 487

Belize City

BENIN

B. P. 971

Cotonou

BOTSWANA

P. O. Box 93

Gaborone

CAMEROON

B P 817

Yaounde

CENTRAL AFRICAN REPUBLIC

B P 1080

Bangui

CHILE

Casilla 27-D

Santiago

COSTA RICA

Apartado Postal

1266

San Jose

DOMINICAN REPUBLIC

Apartado Postal

1412

San Domingo

EASTERN CARIBBEAN

Including: Antigua, Barbados, Grenada, Montserrat, St. Kitts-Nevis, St. Lucia, St. Vincent, Dominica "Erin Court" Bishops Court Hill

P. O. Box 696-C

Bridgetown, Barbados

ECUADOR

Casilla 635-A

Quito

FIJI

P. O. BOX 1094

Suva

GABON

BP 2098

Libreville

GAMBIA, The

P. O. Box 5796

Accra (North)

GHANA

P.O Box 5796

Accra (North)

GUATEMALA

6a Avenida 1-46

Zona 2

Guatemala

HONDURAS

Apartado Postal

C-51

Tegucigalpa

JAMAICA

9 Musgrove Avenue

Kingston 10

KENYA

P. O. Box 30518

Nairobi

LESOTHO

P. O. Box 554

Maseru

LIBERIA

Box 707

Monrovia

MALAWI

Box 208

Lilongwe

MALAYSIA

177 Jalan Raja Muda

Kuala Lumpur

MALI

BP 222

Box 564

MAURITANIA

B P 222

Nouakchott

MICRONESIA

P.O. Box 336

Saipan, Mariana

Islands

MOROCCO

1, Rue Benzerte

Rabat

NEPAL

P. O. Box 613

Kathmandu

NIGER

B P 10537

Niamey

OMAN

P.O Box 966

Muscat

PAPUA NEW GUINEA

c/o American Embassy

Port Moresby

PARAGUAY

c/o American Embassy

Asuncion

PHILIPPINES

P. O. Box 7013

Manila

RWANDA

c/o American Embassy

Kigali

SENEGAL

B P 254

Dakar

SEYCHELLES

Box 564

Victoria

SIERRA LEONE

Private Mail Bag

Freetown

SOLOMON ISLAND

P. O. Box 547

Honiara

TANZANIA

Box 9123

Dar es Salaam

THAILAND

42 Soi Somprasong 2

Petchburi Road

Bangkok 4

TOGO

B P 3194

Lome

TONGA

B P 147

Nuku' Alofa

TUNISIA

8, Ave. Louis Braille

Tunis

WESTERN SAMOA

P.O Box 880

Apia

YEMEN

P.O. Box 1151

Sana'a

ZAIRE

B P 697

Kinshasa